

DS-TDSB0G-FK/120m 120 m Security Radar



DS-TDSB0G-FK/120m security radar, which adopts with radar technology including phased array technology, low-power FMCW modulation technology, is ideal choose for intrusion detection even in challenging conditions like darkness, fog and moderate rainfall. It can also support multi-target positioning, tracing and linking cameras for tracking and recording. Besides, the embedded deep learning algorithm in radar can be also used to detect interested objects only for human and vehicle base on the video stream from linked camera. It is recommend to be used in the prison, power station, railway, museum, airport and other security place.

- Supports getting information such as the distance, speed, and angle of the object.
- Supports target locating and trace following.
- Multi-target locking and multi-dimensional videos linkage.
- Multi-scene modes selectable. Sensitivity configurable.
- Local videos analysis recheck and pictures capture to filter the false alarms such as the swaying trees and pets.
- Supports 32 targets detection, 16 detection zones, and 4 warning lines.
- Strong environment adaptability with 24/7 all-weather working properly
- Water and dust resistant (IP67) and vandal proof (IK10).

▪ Specification

Radar	
Working Frequency	24.05 to 24.25 GHz
Modulation Waveform	FMCW
Sweep Bandwidth	115 MHz
Scan Rate	Up to 12 time(s) per second
Horizontal Detection Angle	120°
Vertical Detection Angle	30°
Max. Detectable Targets	Up to 32 target(s)
Max. Detectable Zones	Up to 16 zone(s)
Max. Detection Trigger Lines	Up to 4 trigger line(s)
Detection Target Type	Human, Vehicle
Detection Distance	Human: 120 m, Vehicle: 200 m
Distance Resolution	1.3 m
Distance Measurement Accuracy	± 1.2 m
Angle Resolution	12°
Angle Accuracy	± 1 °
Speed Measuring Range	- 19 to 19 m/s
Speed Resolution	0.075 m/s
Speed Measuring Accuracy	± 0.1 m/s
Function	
Radar + PTZ Smart Tracking	Supported
Zone Settings	Warning zone, Early warning zone, Disable zone
Tracking Mode	Time priority, Range priority, Multi-target auto switch, Target trigger priority
Scene Mode	Expert mode, Open mode, Shrub mode
Map Management	Supported
Network	
Protocols	TCP/IP, HTTP, HTTPS, DHCP, DNS, RTP, RTSP, NTP, IPv4/IPv6, UDP, SSL/TLS, ARP
Simultaneous Live View	Up to 32 channel(s)
API	SDK, ISAPI
User/Host	Up to 16 users, 3 user levels: administrator, operator, and user
Security	Password protection, Complicated password, HTTPS encryption, Basic and digest authentication for HTTP/HTTPS, RTP/RTSP over HTTPS, Control timeout settings, TLS 1.2, Host authentication (MAC address)
Client	iVMS-4200, Hik-Central Pro
Web Browser	Chrome V61+, IE9 to IE11, Firefox V41+, Edge
Interface	
Network Interface	1 RJ45 10 M/100 M/1000 M self-adaptive Ethernet port(s)
On-Board Storage	Built-in 128 G memory card
Alarm	1 input, 4 Relay output(s) (max. 30 VDC/125 VAC, 1 A)
RS-485	1 RS-485
RS-232	1 RS-232
Indicator	Supported

General	
Power	36 VDC ± 25%, 0.67 A, max. 24 W, two-core terminal block, 24 VAC ± 25%, 1 A, max. 24 W, two-core terminal block
Material	Cover: PC, main body: ADC 12
Dimensions	228 mm × 206 mm × 61 mm (8.98" × 8.11" × 2.4") (L × W × H)
Package Dimensions	489 mm × 300 mm × 140 mm (19.25" × 11.81" × 5.51") (L × W × H)
Weight	Approx. 1.8 kg (3.97 lb.)
With Package Weight	Approx. 3.6 kg (7.94 lb.)
Operating Condition	-40 °C to 65 °C (-40 °F to 149 °F). Humidity 95% or less (non-condensing)
Storage Condition	-40 °C to 60 °C (-40 °F to 140 °F). Humidity 95% or less (non-condensing)
Installation Height	2 to 4 m (Recommend height: 2.5 m)
Approval	
EMC	CE-EMC: EN 55032: 2015 + A11: 2020 + A1: 2020, EN IEC61000-3-2: 2019 + A1: 2021, EN 61000-3-3: 2013 + A1: 2019 + A2: 2021, EN 50130-4: 2011 + A1: 2014
RF	CE-RED: EN 301489-1 V2.2.3, EN 301489-3 V2.1.1, EN 300440 V2.1.1, EN IEC 62311: 2020
Safety	CB: IEC 61010-1: 2010, IEC 61010-1: 2010/AMD1: 2016, CE-LVD: EN 61010-1: 2010 + A1: 2019
Environment	CE-RoHS: 2011/65/EU, WEEE: 2012/19/EU, Reach: Regulation (EC) No 1907/2006
Protection	IK10: IEC 62262: 2002, IP67: IEC 60529: 1989 + A1: 1999 + A2: 2013
Anti-Corrosion Protection	NEMA 4X (NEMA 250-2018)

▪ Typical Application

Hikvision products are classified into three levels according to their anti-corrosion performance. Refer to the following description to choose for your using environment.

This model has MODERATE PROTECTION.

Level	Description
Top-level protection	Hikvision products at this level are equipped for use in areas where professional anti-corrosion protection is a must. Typical application scenarios include coastlines, docks, chemical plants, and more.
Moderate protection	Hikvision products at this level are equipped for use in areas with moderate anti-corrosion demands. Typical application scenarios include coastal areas about 2 kilometers (1.24 miles) away from coastlines, as well as areas affected by acid rain.
No specific protection	Hikvision products at this level are equipped for use in areas where no specific anti-corrosion protection is needed.

▪ **Available Model**

DS-TDSB0G-FK/120m

▪ **Dimension**

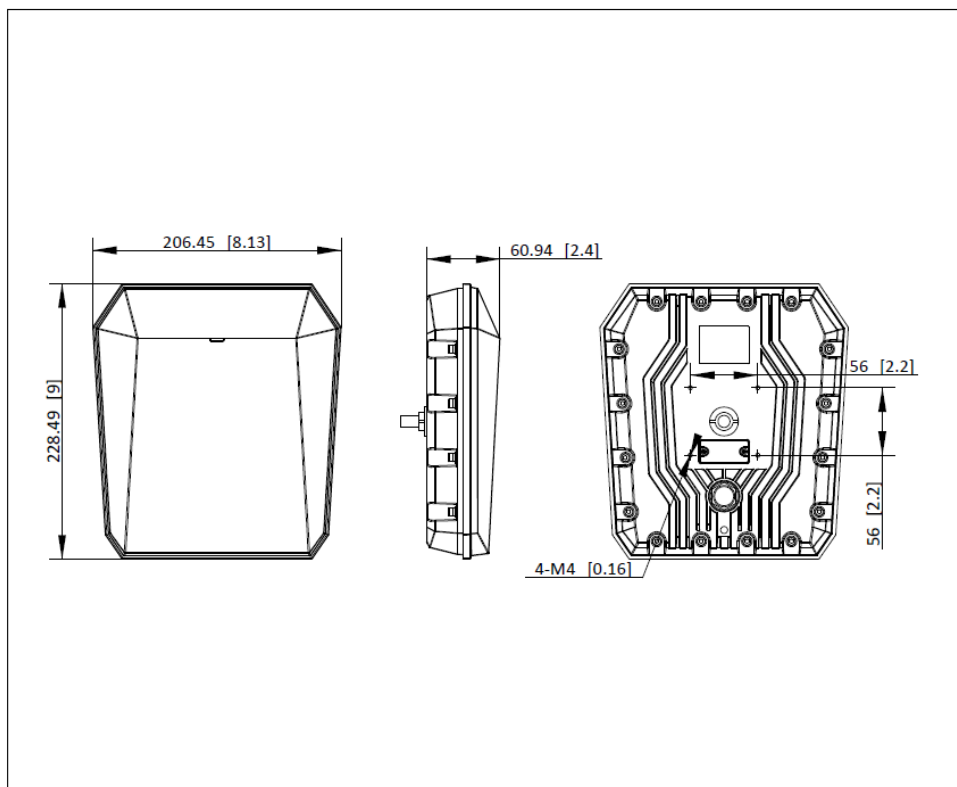







L × W × H: 228.49mm × 206.45mm × 60.94mm (9 × 8.13 × 2.4)

Camera Mounting Hole[mm]	Camera Mounting Hole[inch]	Unit: mm [inch]	
4-M4	4-0.16	SCALE	1:1

▪ **Accessory**

▪ **Optional**

DS-PRB-1110	DS-PRB-1310	DS-PRB-1200	DS-PRB-2200	DS-PRB-1120	DS-PRB2221	DS-PRB2321
Radar	Radar	Radar	Radar	Radar	Radar	Radar
Bracket	Bracket	Bracket	Bracket	Bracket	Bracket	Bracket
						

Headquarters

No.555 Qianmo Road, Binjiang District,
Hangzhou 310051, China
T +86-571-8807-5998
www.hikvision.com



Follow us on social media to get the latest product and solution information.

