



Network Video Recorder
Quick Start Guide

TABLE OF CONTENTS

Chapter 1 Panels Description	7
1.1 Front Panel	7
1.1.1 iDS-96000NXI-I16 Series.....	7
1.1.2 iDS-96000NXI-I24 Series.....	8
1.1.3 iDS-9600NXI-I8/4F and iDS-9600NI-I8/S Series	9
1.1.4 iDS-9600NXI-I16/4F and iDS-9600NXI-I16/16S Series	10
1.1.5 iDS-7700NXI-I4/(16P)/8S Series	11
1.1.6 iDS-6700NXI-I/4F Series	12
1.2 Rear Panel	13
1.2.1 iDS-96000NXI-I16/24 Series	13
1.2.2 iDS-9600NXI-I8/4F and iDS-9600NI-I8/S Series	15
1.2.3 iDS-9600NXI-I16/4F Series	16
1.2.4 iDS-7700NXI-I4/(16P)/8S Series	17
1.2.5 iDS-6700NXI-I/4F Series	18
Chapter 2 Installation and Connections.....	20
2.1 Installation.....	20
2.2 Hard Disk Installation	20
2.2.1 iDS-96000NXI-I16/24 Series	20
2.2.2 iDS-7700NXI-I4/(16P)/8S Series	23
2.2.3 Other Series.....	24
2.3 Connections.....	26
2.3.1 Alarm Input Wiring	26
2.3.2 Alarm Output Wiring.....	26
2.3.3 Alarm Connection	27
2.3.4 Controller Connection	27
2.4 HDD Storage Calculation Chart	28
Chapter 3 Menu Operation	29
3.1 Start up Your Device	29
3.2 Activate Your Device.....	29
3.3 Configure Unlock Pattern for Login	30
3.4 Log into the System	31
3.5 Enter Wizard to Configure Quick Basic Settings	32
3.6 Network Settings.....	33
3.7 Add IP Cameras	33
3.8 Start Live View	34
3.9 One-Touch RAID Configuration	35
3.10 Recording Settings.....	36
3.11 Playback	37
Chapter 4 Face Picture Comparison	39
Chapter 5 Access by Web Browser	40

Quick Start Guide

COPYRIGHT ©2018 Hangzhou Hikvision Digital Technology Co., Ltd.

ALL RIGHTS RESERVED.

Any and all information, including, among others, wordings, pictures, graphs are the properties of Hangzhou Hikvision Digital Technology Co., Ltd. or its subsidiaries (hereinafter referred to be “Hikvision”). This user manual (hereinafter referred to be “the Manual”) cannot be reproduced, changed, translated, or distributed, partially or wholly, by any means, without the prior written permission of Hikvision. Unless otherwise stipulated, Hikvision does not make any warranties, guarantees or representations, express or implied, regarding to the Manual.

About this Manual

This Manual is applicable to Network Video Recorder (NVR).

The Manual includes instructions for using and managing the product. Pictures, charts, images and all other information hereinafter are for description and explanation only. The information contained in the Manual is subject to change, without notice, due to firmware updates or other reasons. Please find the latest version in the company website (<http://overseas.hikvision.com/en/>).

Please use this user manual under the guidance of professionals.

Trademarks Acknowledgement

HIKVISION and other Hikvision’s trademarks and logos are the properties of Hikvision in various jurisdictions. Other trademarks and logos mentioned below are the properties of their respective owners.

Legal Disclaimer

TO THE MAXIMUM EXTENT PERMITTED BY APPLICABLE LAW, THE PRODUCT DESCRIBED, WITH ITS HARDWARE, SOFTWARE AND FIRMWARE, IS PROVIDED “AS IS”, WITH ALL FAULTS AND ERRORS, AND HIKVISION MAKES NO WARRANTIES, EXPRESS OR IMPLIED, INCLUDING WITHOUT LIMITATION, MERCHANTABILITY, SATISFACTORY QUALITY, FITNESS FOR A PARTICULAR PURPOSE, AND NON-INFRINGEMENT OF THIRD PARTY. IN NO EVENT WILL HIKVISION, ITS DIRECTORS, OFFICERS, EMPLOYEES, OR AGENTS BE LIABLE TO YOU FOR ANY SPECIAL, CONSEQUENTIAL, INCIDENTAL, OR INDIRECT DAMAGES, INCLUDING, AMONG OTHERS, DAMAGES FOR LOSS OF BUSINESS PROFITS, BUSINESS INTERRUPTION, OR LOSS OF DATA OR DOCUMENTATION, IN CONNECTION WITH THE USE OF THIS PRODUCT, EVEN IF HIKVISION HAS BEEN ADVISED OF THE POSSIBILITY OF SUCH DAMAGES.

REGARDING TO THE PRODUCT WITH INTERNET ACCESS, THE USE OF PRODUCT SHALL BE WHOLLY AT YOUR OWN RISKS. HIKVISION SHALL NOT TAKE ANY RESPONSIBILITIES FOR ABNORMAL OPERATION, PRIVACY LEAKAGE OR OTHER DAMAGES RESULTING FROM CYBER ATTACK, HACKER ATTACK, VIRUS INSPECTION, OR OTHER INTERNET SECURITY RISKS; HOWEVER, HIKVISION WILL PROVIDE TIMELY TECHNICAL SUPPORT IF REQUIRED.

SURVEILLANCE LAWS VARY BY JURISDICTION. PLEASE CHECK ALL RELEVANT LAWS IN YOUR JURISDICTION BEFORE USING THIS PRODUCT IN ORDER TO ENSURE THAT YOUR USE CONFORMS THE APPLICABLE LAW. HIKVISION SHALL NOT BE LIABLE IN THE EVENT THAT THIS PRODUCT IS USED WITH ILLEGITIMATE PURPOSES.

IN THE EVENT OF ANY CONFLICTS BETWEEN THIS MANUAL AND THE APPLICABLE LAW, THE LATER PREVAILS.

Regulatory Information

FCC Information

Please take attention that changes or modification not expressly approved by the party responsible for compliance could void the user's authority to operate the equipment.

FCC compliance: This equipment has been tested and found to comply with the limits for a Class A digital device, pursuant to part 15 of the FCC Rules. These limits are designed to provide reasonable protection against harmful interference when the equipment is operated in a commercial environment. This equipment generates, uses, and can radiate radio frequency energy and, if not installed and used in accordance with the instruction manual, may cause harmful interference to radio communications. Operation of this equipment in a residential area is likely to cause harmful interference in which case the user will be required to correct the interference at his own expense.

FCC Conditions

This device complies with part 15 of the FCC Rules. Operation is subject to the following two conditions:

1. This device may not cause harmful interference.
2. This device must accept any interference received, including interference that may cause undesired operation.

EU Conformity Statement

 This product and - if applicable - the supplied accessories too are marked with "CE" and comply therefore with the applicable harmonized European standards listed under the EMC Directive 2014/30/EU, the LVD Directive 2014/35/EU, the RoHS Directive 2011/65/EU.

 2012/19/EU (WEEE directive): Products marked with this symbol cannot be disposed of as unsorted municipal waste in the European Union. For proper recycling, return this product to your local supplier upon the purchase of equivalent new equipment, or dispose of it at designated collection points. For more information see: www.recyclethis.info

 2006/66/EC (battery directive): This product contains a battery that cannot be disposed of as unsorted municipal waste in the European Union. See the product documentation for specific battery information. The battery is marked with this symbol, which may include lettering to indicate cadmium (Cd), lead (Pb), or mercury (Hg). For proper recycling, return the battery to your supplier or to a designated collection point. For more information see: www.recyclethis.info

Industry Canada ICES-003 Compliance

This device meets the CAN ICES-3 (A)/NMB-3(A) standards requirements.



Applicable Models

This manual is applicable to the models listed in the following table.

Series	Model
DS-96000NI-I16/24	iDS-96064NXI-I16
	iDS-96128NXI-I16
	iDS-96128NXI-I24
iDS-9600NXI-I16/4F	iDS-9616NXI-I16/4F
	iDS-9632NXI-I16/4F
	iDS-9664NXI-I16/4F
iDS-9600NXI-I8/4F	iDS-9632NXI-I8/4F
	iDS-9664NXI-I8/4F
iDS-9600NI-I8/S	iDS-9632NXI-I8/8S
	iDS-9632NXI-I8/16S
	iDS-9664NXI-I8/16S
iDS-9600NXI-I16/16S	iDS-9616NXI-I16/16S
	iDS-9632NXI-I16/16S
	iDS-9664NXI-I16/16S
iDS-7700NXI-I4/8S	iDS-7716NXI-I4/8S
	iDS-7732NXI-I4/8S
iDS-7700NXI-I4/16P/8S	iDS-7716NXI-I4/16P/8S
	iDS-7732NXI-I4/16P/8S
iDS-6700NXI	iDS-6700NXI-I/4F

Symbol Conventions

The symbols that may be found in this document are defined as follows.

Symbol	Description
 NOTE	Provides additional information to emphasize or supplement important points of the main text.
 WARNING	Indicates a potentially hazardous situation, which if not avoided, could result in equipment damage, data loss, performance degradation, or unexpected results.
 DANGER	Indicates a hazard with a high level of risk, which if not avoided, will result in death or serious injury.

Safety Instructions

- Proper configuration of all passwords and other security settings is the responsibility of the installer and/or end-user.
- In the use of the product, you must be in strict compliance with the electrical safety regulations of the nation and region. Please refer to technical specifications for detailed information.
- Input voltage should meet both the SELV (Safety Extra Low Voltage) and the Limited Power Source with 100~240 VAC or 12 VDC according to the IEC60950-1 standard. Please refer to technical specifications for detailed information.
- Do not connect several devices to one power adapter as adapter overload may cause over-heating or a fire hazard.
- Please make sure that the plug is firmly connected to the power socket.
- If smoke, odor or noise rise from the device, turn off the power at once and unplug the power cable, and then please contact the service center.

Preventive and Cautionary Tips

Before connecting and operating your device, please be advised of the following tips:

- Ensure unit is installed in a well-ventilated, dust-free environment.
- Unit is designed for indoor use only.
- Keep all liquids away from the device.
- Ensure environmental conditions meet factory specifications.
- Ensure unit is properly secured to a rack or shelf. Major shocks or jolts to the unit as a result of dropping it may cause damage to the sensitive electronics within the unit.
- Use the device in conjunction with an UPS if possible.
- Power down the unit before connecting and disconnecting accessories and peripherals.
- A factory recommended HDD should be used for this device.
- Improper use or replacement of the battery may result in hazard of explosion. Replace with the same or equivalent type only. Dispose of used batteries according to the instructions provided by the battery manufacturer.

Chapter 1 Panels Description

1.1 Front Panel

1.1.1 iDS-96000NXI-I16 Series

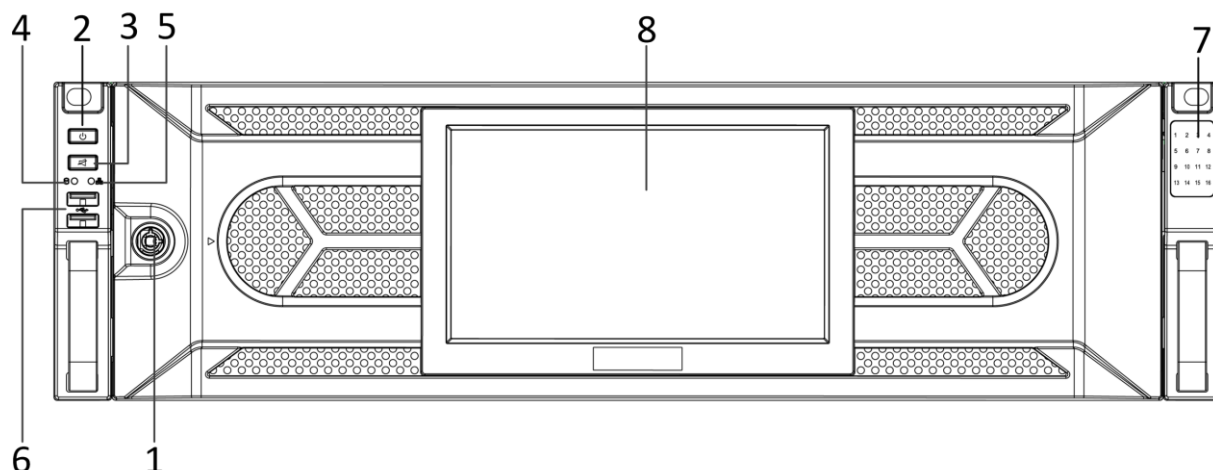

Figure 1-1 Front Panel

Table 1-1 Panel Description

No.	Name	Function Description
1	Front Panel Lock	Locks or unlocks the panel by the key.
2	Power button	<ul style="list-style-type: none"> ● Turn on/off device. ● Solid blue: device is on. ● Solid red: device is off.
3	Mute button	<ul style="list-style-type: none"> ● Turn on/off alarm beep. ● Solid blue: Alarm sound is off. ● Unlit: Alarm sound is on.
4	HDD indicator	<ul style="list-style-type: none"> ● Solid red: at least one HDD is installed ● Unlit: no HDD is detected. ● Blinking red: HDD is reading/writing.
5	Tx/Rx	Flashing blue: network transmission is normal.
6	USB interfaces	USB 2.0 ports for additional devices such as USB mouse and USB Hard Disk Drive (HDD).

7	HDD sequence indicator	Shows the HDD sequence.
8	LCD	7-inch LCD for live-view image and menu operation.

1.1.2 iDS-96000NXI-I24 Series

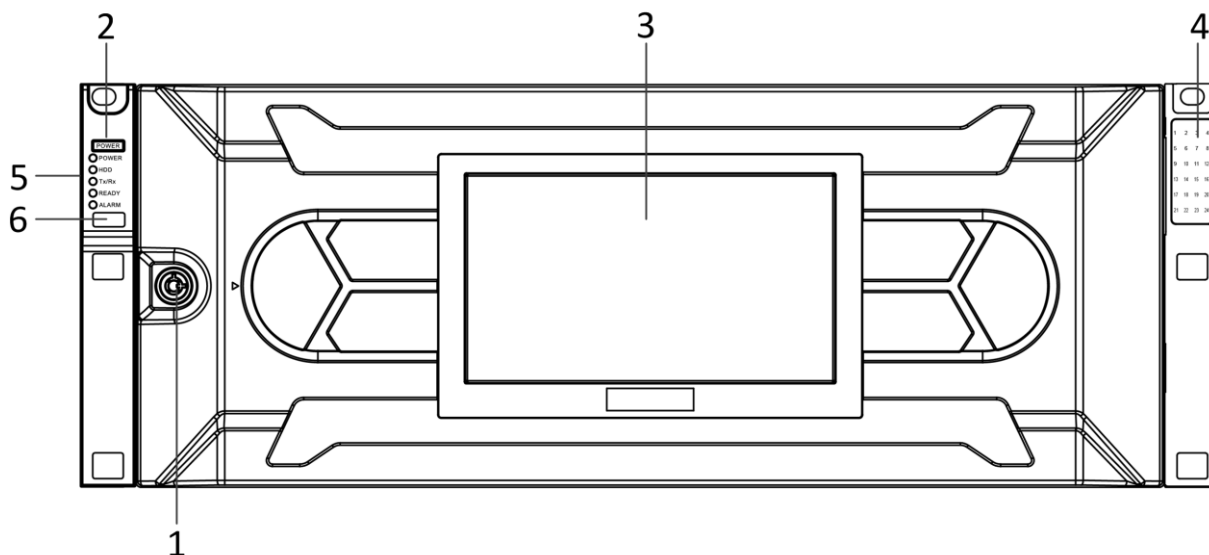

Figure 1-2 Front Panel

Table 1-2 Panel Description

No.	Name	Function Description
1	Front Panel Lock	Locks or unlocks the panel by the key.
2	Power button	<ul style="list-style-type: none"> ● Turn on/off device. ● Solid blue: device is on. ● Solid red: device is off.
3	LCD	7-inch LCD for live-view image and menu operation.
4	HDD sequence indicator	Shows the HDD sequence.
5	Power indicator	Flashing blue: network transmission is normal.
	HDD indicator	<ul style="list-style-type: none"> ● Solid red: at least one HDD is installed ● Unlit: no HDD is detected. ● Blinking red: HDD is reading/writing.
	Tx/Rx indicator	Flashing blue: network transmission is normal.

	Ready indicator	Solid blue: Device in running normally.
	Alarm indicator	Solid red: Relay alarm occurs.
6	USB interfaces	USB port for additional devices such as USB mouse and USB Hard Disk Drive (HDD).

1.1.3 iDS-9600NXI-I8/4F and iDS-9600NI-I8/S Series

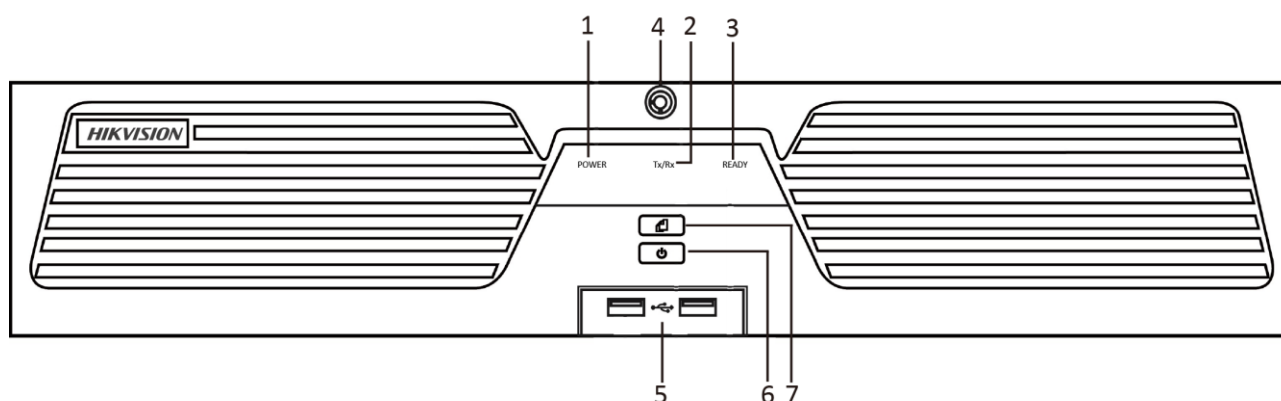

Figure 1-3 Front Panel

Table 1-3 Panel Description

No.	Name	Function Description
1	POWER	Turns red when the power is connected but the system isn't running; turns blue when the power is connected and the system is running.
2	Tx/Rx	Flickers blue when network connection is functioning properly.
3	READY	Turns blue when the device is functioning properly.
4	Front Panel Lock	Locks or unlocks the panel by the key.
5	USB Interfaces	Universal Serial Bus (USB) ports for additional devices such as USB mouse and USB Hard Disk Drive (HDD).
6	POWER ON/OFF	Long press the button for more than 3 seconds to turn on/off the NVR.
7	Backup	Back up video files.

1.1.4 iDS-9600NXI-I16/4F and iDS-9600NXI-I16/16S Series

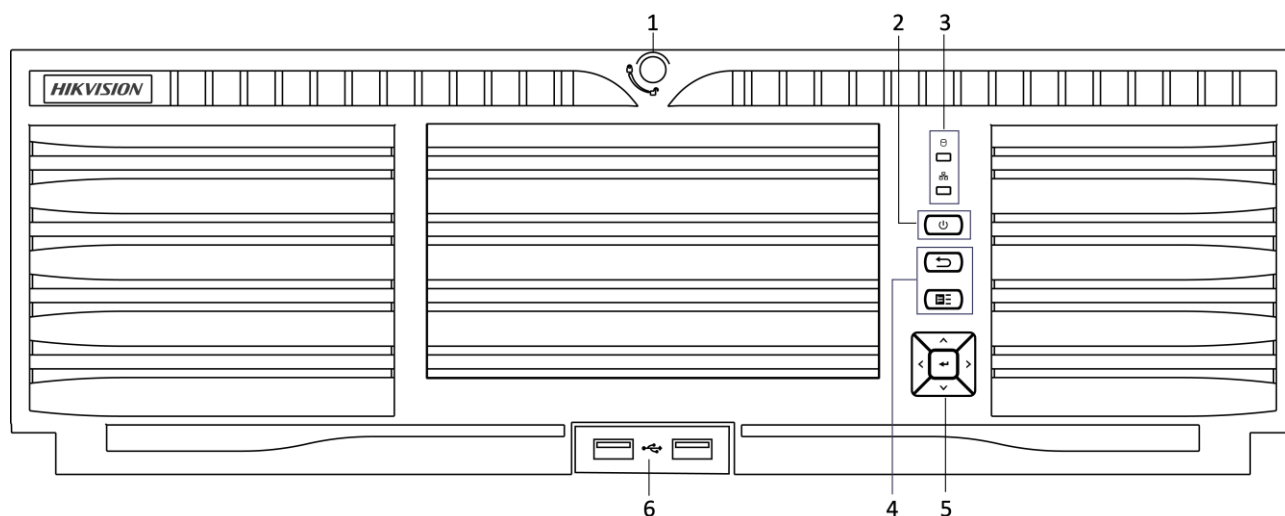

Figure 1-4 Front Panel

Table 1-4 Description

No.	Name	Description
1	Panel lock	Locks or unlocks the panel by the key.
2	Power switch	Powers on/off device. Solid blue indicates device is powered on. Solid red indicates device is shut down.
3	Status indicator	HDD <ul style="list-style-type: none"> ● Solid red: at least one HDD is installed ● Unlit: no HDD is detected. ● Blinking red: HDD is reading/writing.
		Tx/Rx <ul style="list-style-type: none"> ● Blinking blue indicates network communication is normal.
4	Shortcut buttons	Exit <ul style="list-style-type: none"> ● Returns to the previous menu. ● Press it twice quickly to switch the main and auxiliary port. ● In live view mode, press it to enter PTZ control interface.
		Menu <ul style="list-style-type: none"> ● Press it to pop up main menu. ● Hold it for 5 seconds to turn on/off button sound. ● During playback, press it to show/hide control panel.
5	Control buttons	ENTER <ul style="list-style-type: none"> ● Confirms selection in any of the menu modes. ● Checks the checkbox fields.

			<ul style="list-style-type: none"> • Switches on/off status. • Plays or pauses the video playing in playback mode. • Advances the video by a single frame in single-frame playback mode. • Stops/starts auto switch in auto-switch mode.
		DIRECTION	<ul style="list-style-type: none"> • Navigates between different fields and items in menus. • In the playback mode, use the Up and Down buttons to speed up and slow down recorded video. Use the Left and Right buttons to select the next and previous video files. • Cycles through channels in live view mode. • Controls the movement of the PTZ camera in PTZ control mode.
6	USB interfaces		Universal Serial Bus (USB) ports for additional devices such as USB mouse and USB Hard Disk Drive (HDD).

1.1.5 iDS-7700NXI-I4/(16P)/8S Series

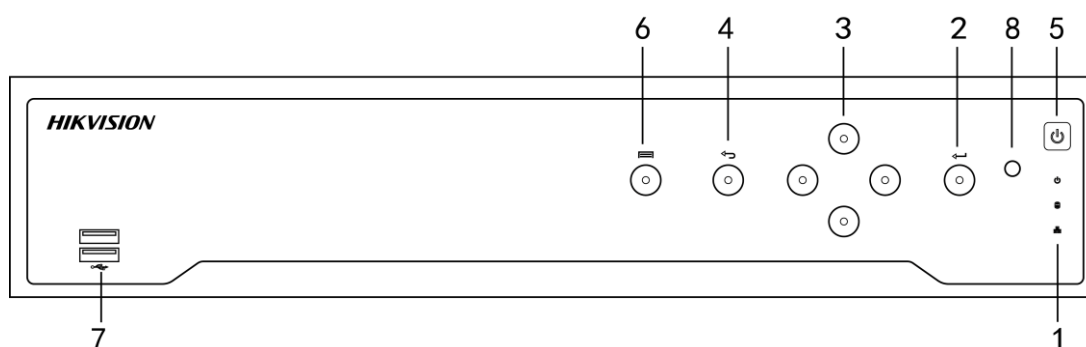

Figure 1-5 Front Panel

Table 1-5 Panel Description

No.	Name	Function Description	
1	Status Indicators	POWER	Turns green when NVR is powered up.
		HDD	Blinks red when HDD is reading/writing.
		Tx/Rx	Blinks green when network connection is functioning normally.
2	ENTER	The Enter button is used to confirm selection in menu mode; or used to check checkbox fields and ON/OFF switch.	

		<p>In playback mode, it can be used to play or pause the video.</p> <p>In single-frame play mode, pressing the Enter button will play the video by a single frame.</p> <p>In auto sequence view mode, the buttons can be used to pause or resume auto sequence.</p> <p>The Enter button is used to confirm selection in menu mode; or used to check checkbox fields and ON/OFF switch.</p>
3	DIRECTION	<p>In menu mode, the direction buttons are used to navigate between different fields and items and select setting parameters.</p> <p>In playback mode, the Up and Down buttons are used to speed up and slow down record playing, and the Left and Right buttons are used to move the recording 30s forwards or backwards.</p> <p>In the image setting interface, the up and down button can adjust the level bar of the image parameters.</p> <p>In live view mode, these buttons can be used to switch channels.</p>
4	Back	Back to the previous menu.
5	POWER ON/OFF	Power on/off switch.
6	MENU	Access the main menu interface.
7	USB Interface	Universal Serial Bus (USB) ports for additional devices such as USB mouse and USB Hard Disk Drive (HDD).

1.1.6 iDS-6700NXI-I/4F Series

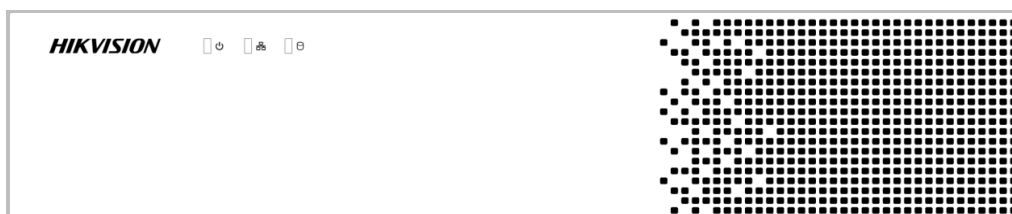





Figure 1-6 Front Panel

Table 1-6 Indicator Description

Item	Description
	Turns red when device is powered up.
	Turns red when data is being read from or written to HDD.
	Flickers blue when network connection is functioning properly.

1.2 Rear Panel

1.2.1 iDS-96000NXI-I16/24 Series

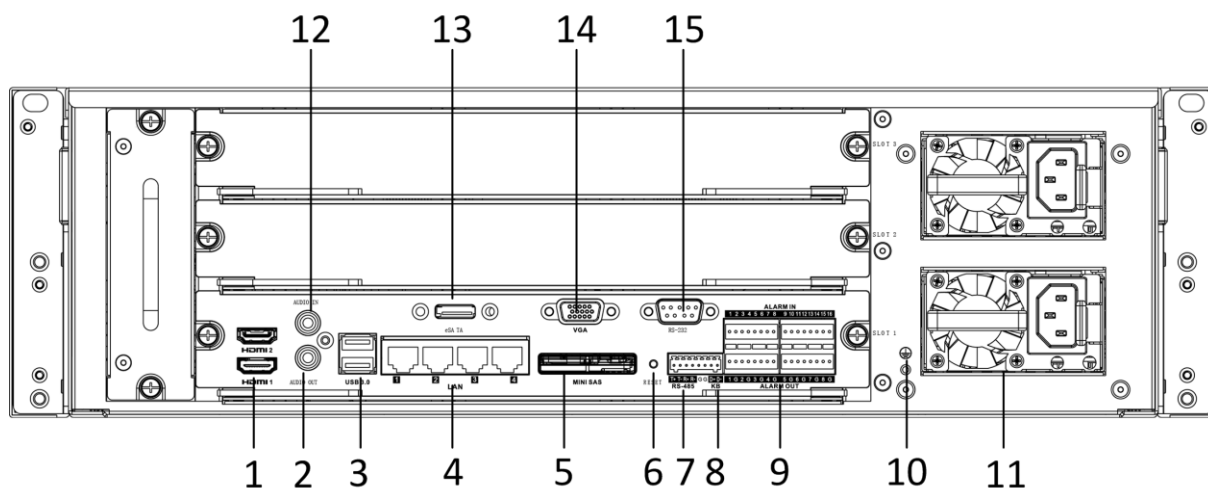

Figure 1-7 Rear Panel

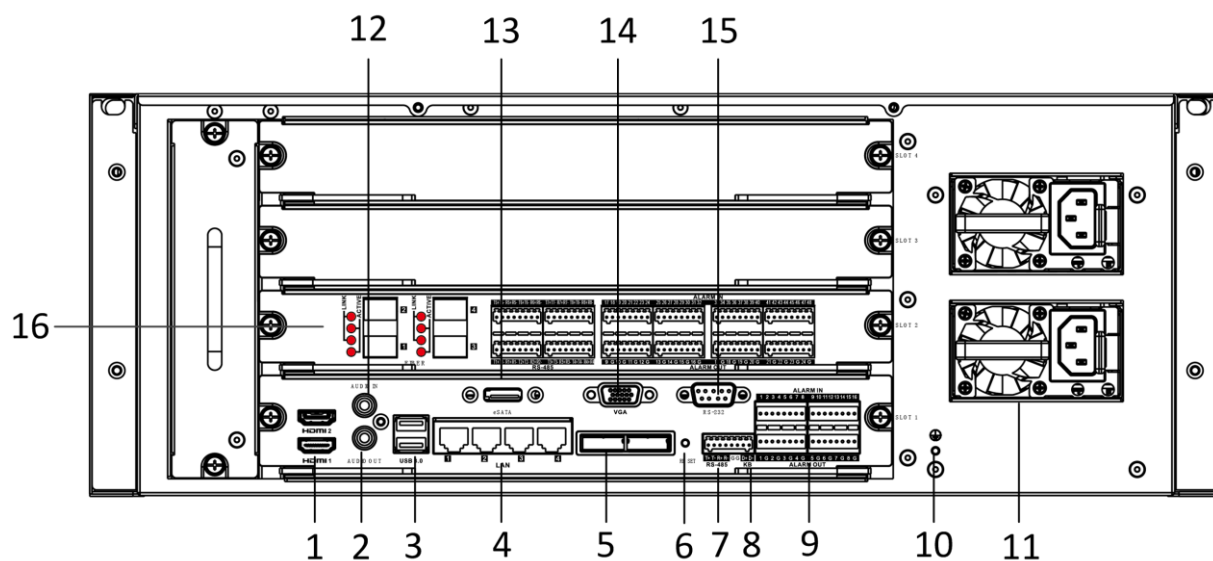

Figure 1-8 iDS-96000NXI-I24 Series

Table 1-7 Panel Description

No.	Name	Description
1	HDMI1/HDMI2	HDMI video output connector.
2	AUDIO OUT	RCA connector for audio output.
3	USB 3.0 interface	Universal Serial Bus (USB) ports for additional devices such as USB mouse and USB Hard Disk Drive (HDD).
4	LAN1/LAN2 Interface	4 RJ-45 10/100/1000 Mbps self-adaptive Ethernet interfaces provided.
5	MiniSAS interface	2 miniSAS interfaces
6	Reset	Reset button
7	RS-485	RS-485 interface
8	KB	Keyboard interface
9	ALARM IN/OUT	Connector for alarm input/output.
10	Ground	Ground (needs to be connected when NVR starts up).
11	Power supply	100 to 240 VAC power supply.
12	Audio IN	RCA connector for audio input.
13	eSATA	Connects external SATA HDD, CD/DVD-RM.
14	VGA	DB9 connector for VGA output. Display local video output and menu.

15	RS-232 Interface	Connector for RS-232 devices.
16	Extension board	<ul style="list-style-type: none"> • 4 × RJ-45 10/100/1000 Mbps self-adaptive optical interface, • 8 × RS-485 (full-duplex), • Alarm input/output: 32/16

1.2.2 iDS-9600NXI-I8/4F and iDS-9600NI-I8/S Series

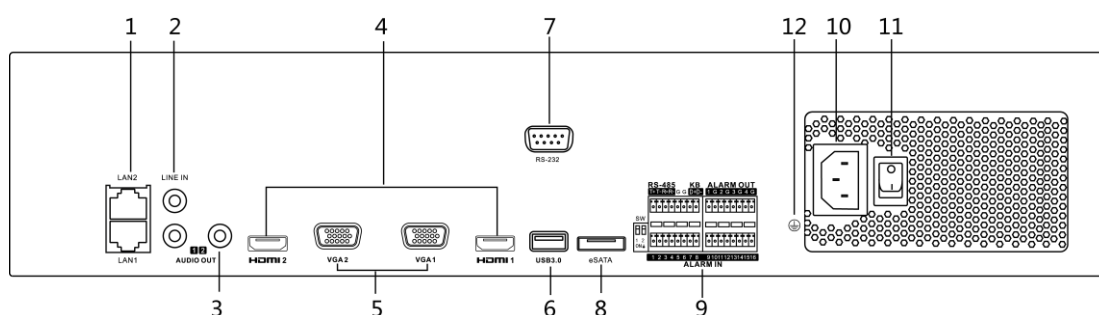

Figure 1-9 Rear Panel

Table 1-8 Panel Description

No.	Name	Description
1	LAN1/LAN2 Interface	2 RJ-45 10/100/1000 Mbps self-adaptive Ethernet interfaces provided.
2	LINE IN	RCA connector for audio input.
3	AUDIO OUT	2 RCA connectors for audio output.
4	HDMI1/HDMI2	HDMI video output connector.
5	VGA1/VGA2	DB9 connector for VGA output. Display local video output and menu.
6	USB 3.0 interface	Universal Serial Bus (USB) ports for additional devices such as USB mouse and USB Hard Disk Drive (HDD).
7	RS-232 Interface	Connector for RS-232 devices.
8	eSATA	Connects external SATA HDD, CD/DVD-RM.
9	Controller Port	D+, D- pin connects to Ta, Tb pin of controller. For cascading devices, the first NVR's D+, D- pin should be connected with the D+, D- pin of the next NVR.

	ALARM IN	Connector for alarm input.
	ALARM OUT	Connector for alarm output.
10	100 to 240 VAC	100 to 240 VAC power supply.
11	Power Switch	Switch for turning on/off the device.
12	GROUND	Ground (needs to be connected when NVR starts up).

1.2.3 iDS-9600NXI-I16/4F Series

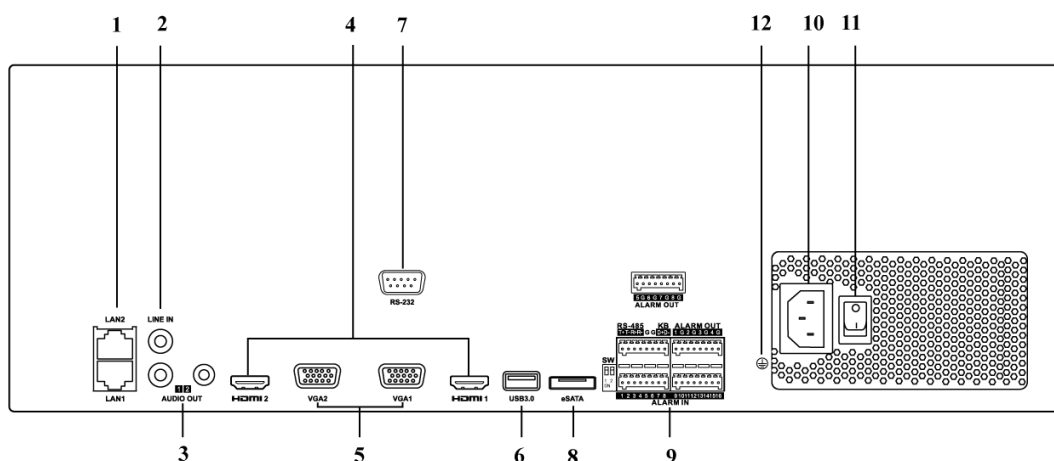

Figure 1-10 Rear Panel

Table 1-9 Panel Description

No.	Name	Description
1	LAN1/LAN2 Interface	2 RJ-45 10/100/1000 Mbps self-adaptive Ethernet interfaces provided.
2	LINE IN	RCA connector for audio input.
3	AUDIO OUT	2 RCA connectors for audio output.
4	HDMI1/HDMI2	HDMI video output connector.
5	VGA1/VGA2	DB9 connector for VGA output. Display local video output and menu.
6	USB 3.0 interface	Universal Serial Bus (USB) ports for additional devices such as USB mouse and USB Hard Disk Drive (HDD).
7	RS-232 Interface	Connector for RS-232 devices.
8	eSATA	Connects external SATA HDD, CD/DVD-RM.

9	Controller Port	D+, D- pin connects to Ta, Tb pin of controller. For cascading devices, the first NVR's D+, D- pin should be connected with the D+, D- pin of the next NVR.
	ALARM IN	Connector for alarm input.
	ALARM OUT	Connector for alarm output.
10	100 to 240 VAC	100 to 240 VAC power supply.
11	Power Switch	Switch for turning on/off the device.
12	GROUND	Ground (needs to be connected when NVR starts up).

1.2.4 iDS-7700NXI-I4/(16P)/8S Series

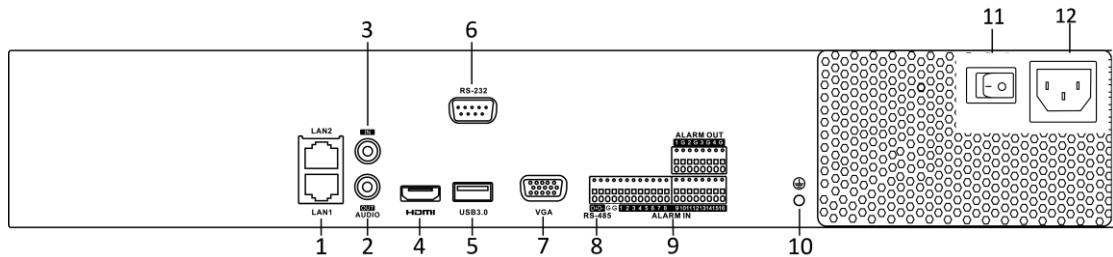

Figure 1-11 iDS-7700NXI-I4/8S Series

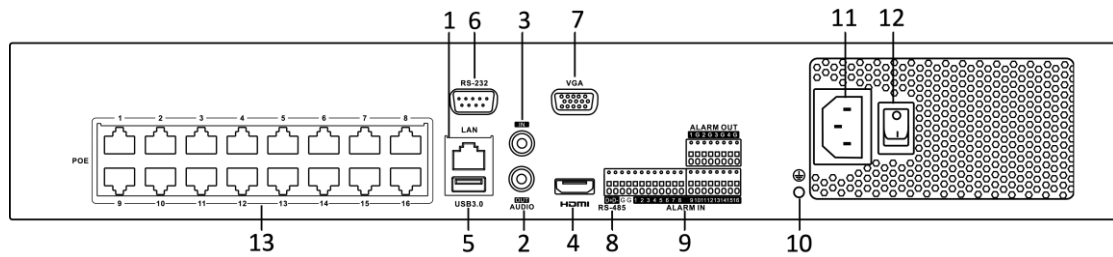

Figure 1-12 iDS-7700NXI-I4/16P/8S Series

 **NOTE**

iDS-7716NXI-I4/8S and iDS-7732NXI-I4/8S provides 8 PoE interfaces.

Table 1-10 Panel Description

No.	Name	Description
1	LAN Interface	1 network interface provided by iDS-7700NXI-I4/16P/8S , and 2 network interfaces by iDS-7716NXI-I4/8S and iDS-7732NXI-I4/8S .
2	AUDIO OUT	RCA connector for audio output.
3	LINE IN	RCA connector for audio input.
4	HDMI	HDMI video output connector.
5	USB 3.0 interface	Universal Serial Bus (USB) ports for additional devices such as USB mouse and USB Hard Disk Drive (HDD).
6	RS-232 Interface	Connector for RS-232 devices.
7	VGA	DB9 connector for VGA output. Display local video output and menu.
8	RS-485 Interface	Half-duplex connector for RS-485 devices.
9	ALARM IN	Connector for alarm input.
	ALARM OUT	Connector for alarm output.
10	GROUND	Ground (needs to be connected when NVR starts up).
11	AC 100V ~ 240V	100V to 240VAC power supply.
12	Power Switch	Switch for turning on/off the device.
13	Network Interfaces with PoE function (supported by iDS-7700NXI-I4/16P/8S)	Network interfaces for the cameras and to provide power over Ethernet.

1.2.5 iDS-6700NXI-I/4F Series

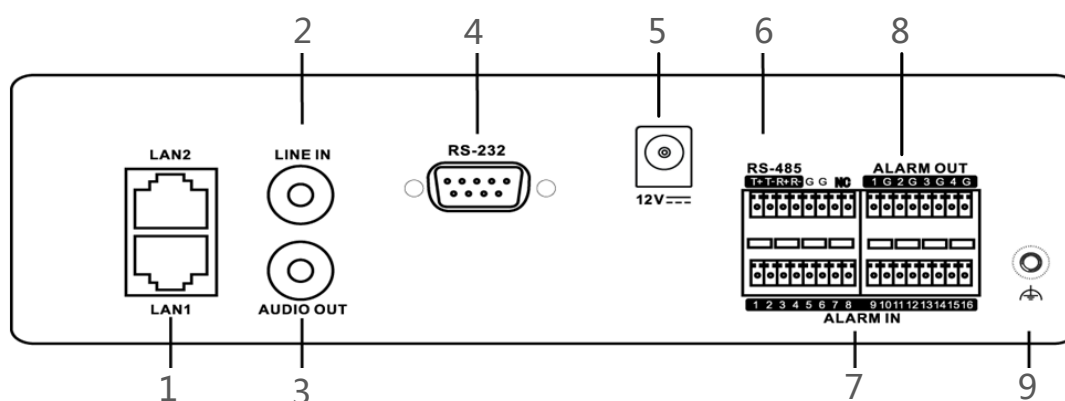

Figure 1-13 Rear Panel

Table 1-11 Interface Description

Index	Item	Description
1	LAN1/LAN2	10M/100Mbps adaptive Ethernet interface
2	LINE IN	3.5mm interface for line in; connect to audio input device or active pick-up, microphone, etc.
3	AUDIO OUT	3.5mm interface; connect to audio output device, e.g., loudspeaker, etc.
4	RS-232	Serial interface for configuration of device's parameters or used as transparent channel.
5	DC12V	12 VDC power supply
6	RS-485	RS-485 serial interface; connect to pan/tilt unit, speed dome, etc.
7	ALARM IN	Relay alarm input.
8	ALARM OUT	Relay alarm output.
9	GND	Grounding

Chapter 2 Installation and Connections

2.1 Installation

During installation of the NVR:

- Use brackets for rack mounting.
- Ensure ample room for audio and video cables.
- When routing cables, ensure that the bend radius of the cables are no less than five times than its diameter.
- Connect the alarm cable.
- Allow at least 2cm (≈0.75-inch) of space between racks mounted devices.
- Ensure the NVR is grounded.
- Environmental temperature should be within the range of -10° C to +55° C (+14° F to +131° F).
- Environmental humidity should be within the range of 10% to 90%.

2.2 Hard Disk Installation

2.2.1 iDS-96000NXI-I16/24 Series

Purpose:

We take the example of iDS-96000NXI-I16 to describe HDD installation

Before you start:

Disconnect the power from the NVR before installing a hard disk drive (HDD). A factory recommended HDD should be used for this installation.

Step 1 Unlock the front panel with the panel key.



Figure 2-1 Unlock the Panel

Step 2 To remove the cover from front panel, follow steps below:

- 1) Gently pull the cover out of the device along the direction arrow ① and make it a little above the left handle. The angle between the cover and the front panel must be within 10°.
- 2) Pull the front panel out of the device along the direction arrow ②.

 **NOTE**

Handle with care to avoid damage.

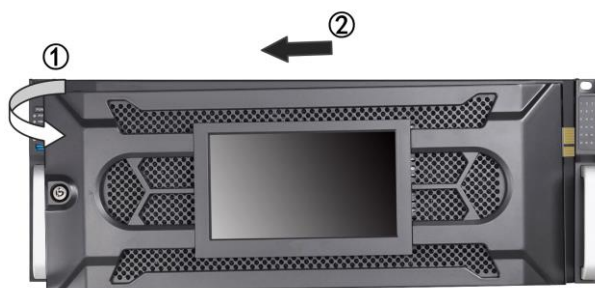

Figure 2-2 Remove the Cover

Step 3 Press the blue button to pop up the handle and hold the handle and pull the dummy HDD out of the slot.



Figure 2-3 Pull out Dummy HDD

Step 4 Fix the hard disk in the dummy HDD.

- 1) Place a hard disk in the dummy HDD. The SATA interface must face the dummy HDD bottom.
- 2) Adjust the hard disk position. Ensure the hard disk rear is aligned with hard disk bottom.
- 3) Use a screwdriver to fasten the four screws into the screw holes that in both sides.



Figure 2-4 Fix the Hard Disk

Step 5 Push the dummy HDD back into the slot.



Figure 2-5 Push the Dummy HDD into the Slot

Step 6 Press the handle until you hear a click. Thus to fix the dummy HDD. Repeat above steps to install the rest dummy HDDs.



Figure 2-6 Press the Handle

Step 7 Install the cover back to front panel. And lock it with panel key.



Figure 2-7 Reinstall the Cover and Lock the Panel

2.2.2 iDS-7700NXI-I4/(16P)/8S Series

Purpose:

The following section introduces the HDD installation for the iDS-7700NXI-I4/8S Series and iDS-7700NXI-I4/16P/8S series NVR. Take the example of iDS-7700NXI-I4/8S to describe installation steps.

Step 1 Remove the cover from the NVR by unfastening the screws on the rear and side panel.



Figure 2-8 Remove Cover

Step 2 Connect one end of the data cable to the motherboard of NVR and the other end to the HDD.

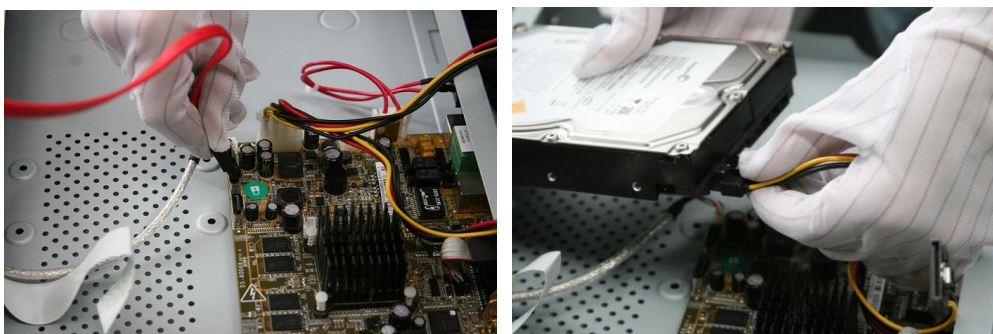

Figure 2-9 Connect Data Cable

Step 3 Connect the power cable to the HDD.



Figure 2-10 Connect Power Cable

Step 4 Place the HDD on the bottom of the device and then fasten the screws on the bottom to fix the HDD.



Figure 2-11 Fix Hard Disk

2.2.3 Other Series

Purpose:

Here we take the example of HDD installation of iDS-9600NXI-I8/4F Series to describe the steps.

Before you start:

Disconnect the power from the NVR before installing a hard disk drive (HDD). A factory recommended HDD should be used for this installation.

Tools Required: Screwdriver.

Step 1 Fasten the hard disk mounting handle to the hard disk with screws.



Figure 2-12 Fasten Hard Disk

Step 2 Insert the key and turn in clockwise direction to open the panel lock.

Step 3 Press the buttons on the panel of two sides and open the front panel.



Figure 2-13 Open Front Panel

Step 4 Insert the hard disk along the slot until it is placed into position.

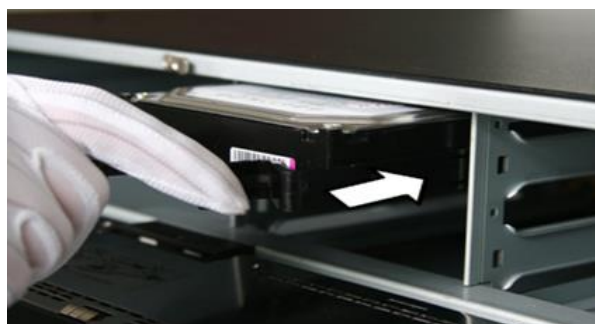

Figure 2-14 Insert HDD to the Slot

Step 5 Repeat the above steps to install other hard disks onto the NVR.

Step 6 After having finished the installation of all hard disks, close the front panel and lock it with the key again.

2.3 Connections

2.3.1 Alarm Input Wiring

The alarm input is an open/closed relay. To connect the alarm input to the device, use the following diagram.



If the alarm input is not an open/close relay, please connect an external relay between the alarm input and the device.

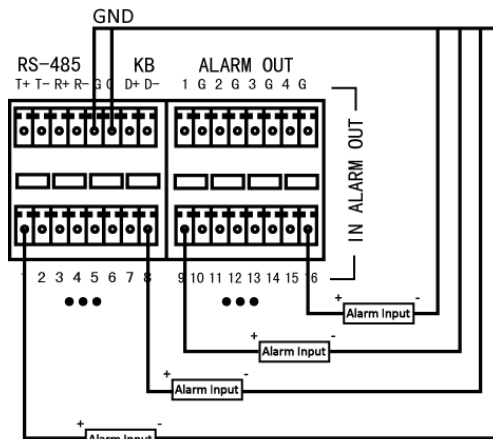

Figure 2-15 Alarm Input Wiring

2.3.2 Alarm Output Wiring

To connect to an alarm output (AC or DC load), use the following diagram:

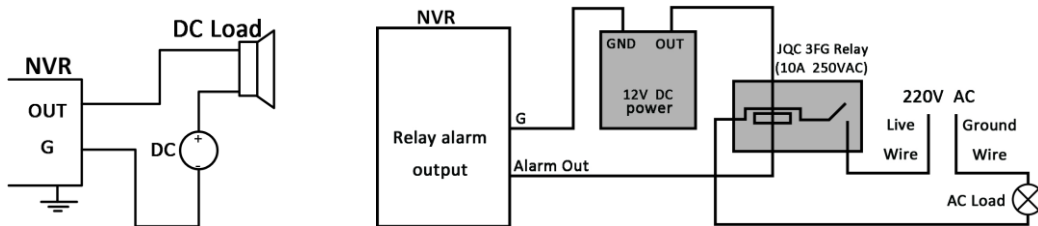

Figure 2-16 Alarm Output Wiring

For DC load, the jumpers can be used within the limit of 12V/1A safely.

To connect an AC load, jumpers should be left open (you must remove the jumper on the motherboard in the NVR). Use an external relay for safety (as shown in the figure above).

There are 4 jumpers (JP6, JP9, JP10, and JP11) on the motherboard, each corresponding with one alarm output. By default, jumpers are connected. To connect an AC load, jumpers should be removed.

Example:

If you connect an AC load to the alarm output 3 of the NVR, then you must remove the JP 3 jumper.

2.3.3 Alarm Connection

To connect alarm devices to the NVR:

Step 1 Disconnect *pluggable block* from the ALARM IN /ALARM OUT terminal block.

Step 2 Unfasten stop screws from the *pluggable block*, insert signal cables into slots and fasten stop screws. Ensure signal cables are tight.

Step 3 Connect *pluggable block* back into terminal block.

2.3.4 Controller Connection

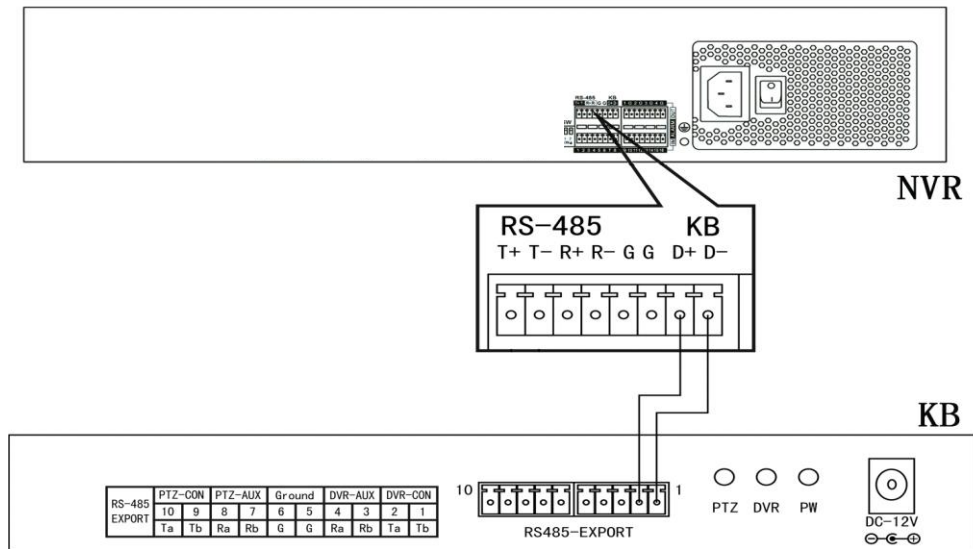

Figure 2-17 Controller Connection

To connect a controller to the NVR:

Step 2 Disconnect pluggable block from the KB terminal block.

Step 3 Unfasten stop screws from the KB D+, D- *pluggable block*, insert signal cables into slots and fasten stop screws. Ensure signal cables are in tight.

Step 4 Connect Ta on controller to D+ on terminal block and Tb on controller to D- on terminal block. Fasten stop screws.

Step 5 Connect *pluggable block* back into terminal block.

 **NOTE**

Make sure both the controller and NVR are grounded.

2.4 HDD Storage Calculation Chart

The following chart shows an estimation of storage space used based on recording at one channel for an hour at a fixed bit rate.

Bit Rate	Storage Used
96K	42M
128K	56M
160K	70M
192K	84M
224K	98M
256K	112M
320K	140M
384K	168M
448K	196M
512K	225M
640K	281M
768K	337M
896K	393M
1024K	450M
1280K	562M
1536K	675M
1792K	787M
2048K	900M
4096K	1.8G
8192K	3.6G
16384K	7.2G

 **NOTE**

Please note that supplied values for storage space used is just for reference. The storage values in the chart are estimated by formulas and may have some deviation from actual value.

Chapter 3 Menu Operation

3.1 Start up Your Device

Proper startup and shutdown procedures are crucial to expanding the life of the NVR.

To start your device:

Step 1 Check the power supply is plugged into an electrical outlet. It is **HIGHLY** recommended that an Uninterruptible Power Supply (UPS) be used in conjunction with the device. The Power button on the front panel should be red, indicating the device is receiving the power.

Step 2 Press the POWER button on the front panel. The Power LED should turn blue. The unit will begin to start.

After the device starts up, the wizard will guide you through the initial settings, including modifying password, date and time settings, network settings, HDD initializing, and recording.

3.2 Activate Your Device

For the first-time access, you need to activate the device by setting an admin password. No operation is allowed before activation. You can also activate the device via Web Browser, SADP or Client Software.

Step 1 Input the same password in the text field of **Create New Password** and **Confirm New Password**.



You can click  to show the characters input.



The screenshot shows a window titled "Activation" with a dark blue header. Below the header, there are two text input fields. The first field contains the text "admin". The second field contains a series of asterisks "*****" and has a small eye icon to its right. Below the second field, there is a "Password Str..." label followed by three colored bars (red, orange, green) and the word "Strong". To the right of these elements, there is a note: "Note: Valid password range [8-16]. You can use a combination of numbers, lowercase, uppercase and special character for your password with at least two kinds of them contained." Below the note, there is a third text input field containing asterisks "*****" and an eye icon. At the bottom of the window, there are two buttons: "OK" and "Cancel".

Figure 3-1 Setting Admin Password

 **WARNING**

We highly recommend you create a strong password of your own choosing (Using a minimum of 8 characters, including at least three of the following categories: upper case letters, lower case letters, numbers, and special characters.) in order to increase the security of your product. And we recommend you reset your password regularly, especially in the high security system, resetting the password monthly or weekly can better protect your product.

Step 2 Click **OK** to save the password and activate the device.

Step 3 When the device is activated, the system pops up the message box to remind you to properly keep the password. And you can click **OK** to continue to export the GUID file for the future password resetting.



Figure 3-2 Properly Keep Password Remind

 **NOTE**

If Admin's password is modified, the following menu pops up. Optionally, click **Yes** to duplicate the password to IP cameras that are connected with default protocol.

3.3 Configure Unlock Pattern for Login

For the admin user, you can configure the unlock pattern for device login.

Step 1 After the device is activated, you can enter the following interface to configure the device unlock pattern.

Step 2 Use the mouse to draw a pattern among the 9 dots on the screen. Release the mouse when the pattern is done.

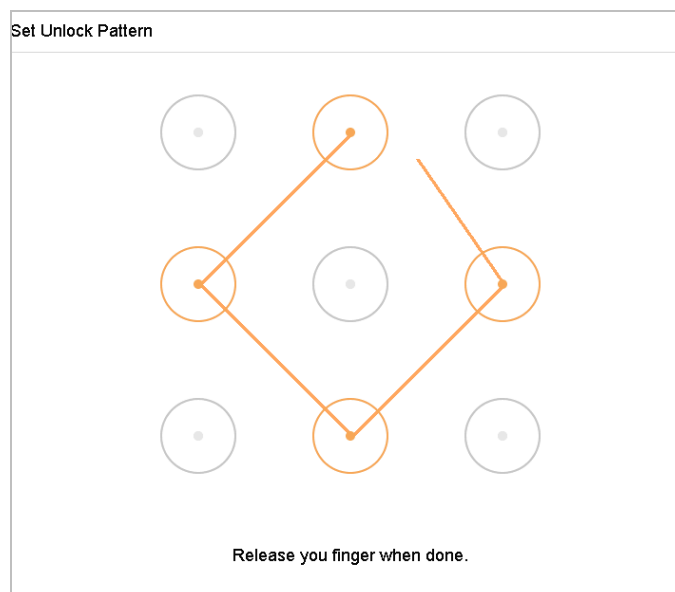

Figure 3-3 Draw the Pattern

 **NOTE**

- Connect at least 4 dots to draw the pattern.
- Each dot can be connected for once only.

Step 3 Draw the same pattern again to confirm it. When the two patterns match, the pattern is configured successfully.

 **NOTE**

If the two patterns are different, you must set the pattern again.

3.4 Log into the System

Purpose:

If the device has logged out, you must log in the device before operating the menu and other functions. You can select to log in by unlock pattern or password input either.

Step 1 Right click the mouse on the screen and select the menu to enter the interface.

Step 2 Select the **User Name** in the dropdown list.

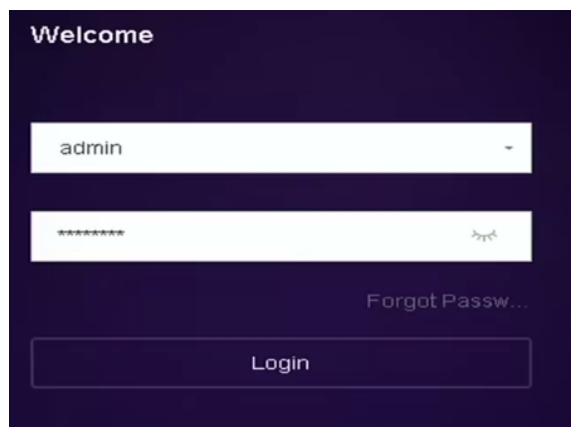

Figure 3-4 Login Interface

Step 3 Input Password.

Step 4 Click **Login** to log in.



NOTE

In the Login dialog box, if you enter the wrong password 7 times, the current user account will be locked for 60 seconds.

3.5 Enter Wizard to Configure Quick Basic Settings

The Setup Wizard can walk you through some important settings of the device. By default, the Setup Wizard starts once the device has loaded.

Check the checkbox to enable Setup Wizard when device starts. Click **Next** to continue the setup wizard. Follow the guide of the Setup Wizard to configure the system resolution, system date/time, network settings, HDD management, record settings, etc.



Figure 3-5 Wizard

3.6 Network Settings

Purpose:

Network settings must be properly configured before you operate device over network.

Step 1 Go to **System > Network > TCP/IP**.

The screenshot shows the 'TCP/IP' configuration page with the following settings:

- Tabs:** TCP/IP (selected), DDNS, PPPoE, NTP, NAT
- Working Mode:** Net Fault-Tolerance
- Select NIC:** bond0
- NIC Type:** 10M/100M/1000M Self-adap
- Enable DHCP:**
- Enable Obtain DNS...:**
- IPv4 Address:** 10 . 15 . 2 . 107
- Preferred DNS Server:** [Empty text box]
- IPv4 Subnet Mask:** 255 . 255 . 255 . 0
- Alternate DNS Server:** [Empty text box]
- IPv4 Default Gateway:** 10 . 15 . 2 . 254
- MAC Address:** a4:14:37:aa:09:a3
- MTU(Bytes):** 1500
- Main NIC:** LAN1
- Buttons:** Apply

Figure 3-6 Network Settings

Step 2 Select the **General** tab.

Step 3 In the **General Settings** interface, you can configure the following settings: NIC Type, IPv4 Address, IPv4 Gateway, MTU and DNS Server.

Step 4 If the DHCP server is available, you can check the checkbox of **DHCP** to automatically obtain an IP address and other network settings from that server.

Step 5 After having configured the general settings, click the **Apply** button to save the settings.

3.7 Add IP Cameras

Purpose:

Before you can get live video or record the video files, you should add the network cameras to the connection list of the device.

Before you start:

Ensure the network connection is valid and correct, and the IP camera to add has already been activated.

Step 1 Click  on the main menu bar to enter the Camera Management.

Step 2 Click the **Custom Add** tab on the title bar to enter the Add IP Camera interface.

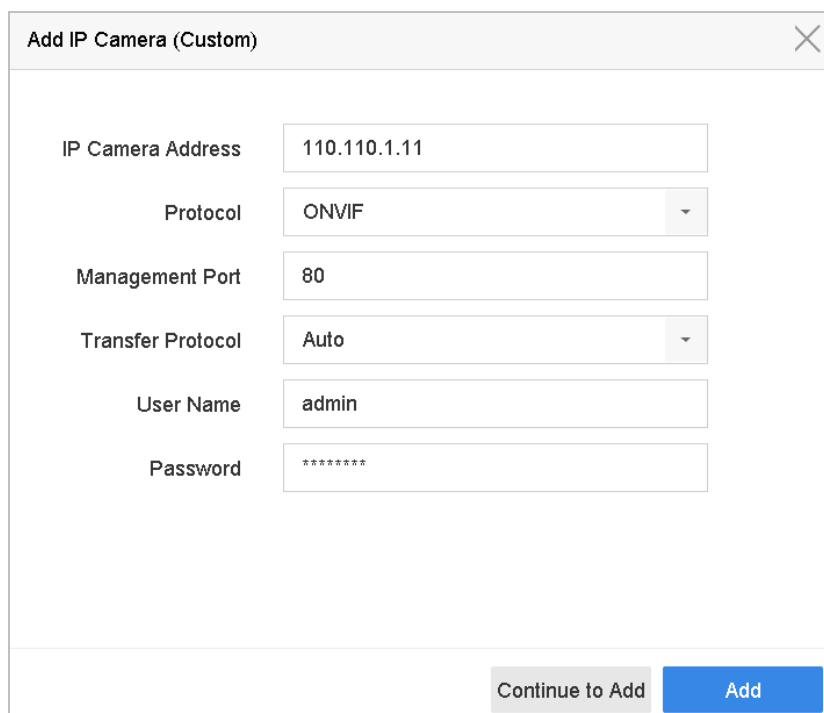

IP Camera Address	110.110.1.11
Protocol	ONVIF
Management Port	80
Transfer Protocol	Auto
User Name	admin
Password	*****

Continue to Add Add

Figure 3-7 Add IP Camera

Step 3 Enter IP address, protocol, management port, and other information of the IP camera to add.

Step 4 Enter the login user name and password of the IP camera.

Step 5 Click **Add** to finish the adding of the IP camera.

Step 6 (Optional) Click **Continue to Add** to continue to add other IP cameras.

3.8 Start Live View

Step 1 The system automatically enters the live view interface when starts up, or you can click the



on the main menu bar to enter the live view interface.

Step 2 Click to select a window for live view.

Step 3 Double click the IP camera on the left list to start playing the live video.



Figure 3-8 Live View

You can use the toolbar at the window bottom to realize the capture, instant playback, audio on/off, digital zoom, live view strategy, show information and start/stop recording, etc.

3.9 One-Touch RAID Configuration

Purpose:

The device supports the RAID storage function. Through one-touch configuration, you can quickly create the disk array. By default, the array type to be created is RAID 5.

Before you start:

- Enable RAID function.
- Install at least 3 HDDs. If more than 10 HDDs are installed, 2 arrays will be created. To maintain reliable and stable running of the HDDs, it is recommended to use enterprise-level HDDs with the same model and capacity.

Step 1 Go to **Storage > RAID Setup > Physical Disk**.

No	Capacity	Array	Type	Status	Model	Hot Spare	Task
<input type="checkbox"/> 1	1863.02GB		Normal	Functional	ST2000VX000-1CU164	<input checked="" type="checkbox"/>	None
<input type="checkbox"/> 5	1863.02GB		Normal	Functional	ST2000VX000-1CU164	<input checked="" type="checkbox"/>	None

Figure 3-9 Physical Disk

Step 2 Click **One-touch Config**.

Step 3 Edit the array name in **Array Name** text field and click **OK** to start configuring.



NOTE

If you install 4 or more HDDs, a hot spare disk for array rebuilding will be created.

Step 4 A message box will pop up when the array creation is completed, click **OK** on it.

Step 5 Optionally, the device will automatically initialize the created array. Go to **Storage > RAID Setup > Array** view the information of created array.

3.10 Recording Settings

Before you start:

Make sure that the disk has already been installed or added. If not, please install or add a disk and initialize it. You may refer to the user manual for detailed information.

Option 1:

In the live view mode, select a connected camera window and click  at the toolbar to start recording.

Option 2:

Step 1 Go to **Storage > Recording Schedule**.

Step 2 Select a camera.

Step 3 Check the **Enable Schedule**.

Step 4 Select a **Record Type**. The record type can be Continuous, Motion Detection, Alarm, Motion | Alarm, Motion & Alarm, Event, etc.

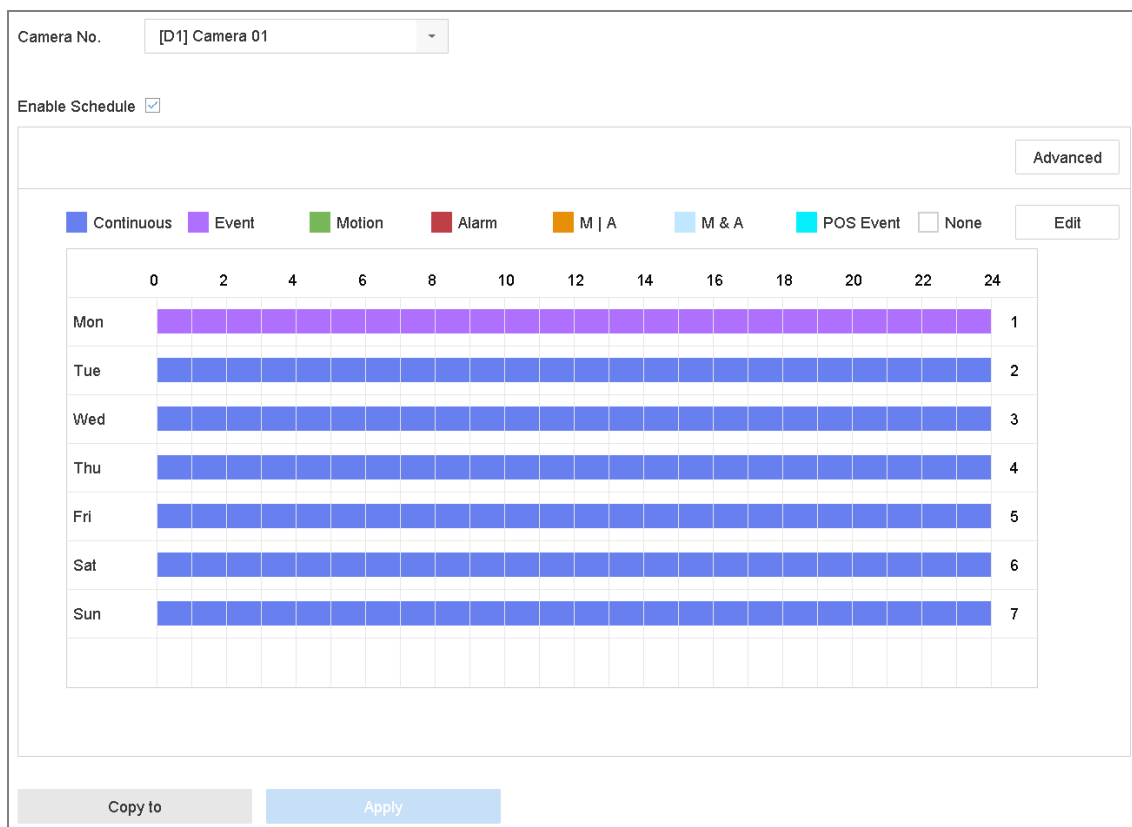

Figure 3-10 Record Schedule

Step 5 Select a day and click-and-drag the mouse on the time bar to set the record schedule.

Step 6 Click **Apply** to save the settings.

3.11 Playback

The recorded video files on the hard disk can be played back in the following modes: instant playback, all-day playback for the specified channel, and playback by normal/important/custom/event/smart/tag/sub-periods/external file search.



Step 1 Click  on the main menu bar to enter the playback interface.

Step 2 Check the channel(s) in the list and then double-click to select a date on the calendar.

Step 3 You can use the toolbar in the bottom part of Playback interface to control playing progress.



Figure 3-11 Playback Interface

Step 4 Select the channel(s) to or execute simultaneous playback of multiple channels.

Chapter 4 Face Picture Comparison

Purpose:

The device supports the face picture comparison alarm and face capture for the connected camera based on face recognition feature. The chapter is only available for iDS-9600NXI-I16/4F and iDS-9600NXI-I8/4F series.

Step 1 Go to **Smart Analysis > Face Picture Database**.

Step 2 Add the face picture library to the device with the face pictures uploaded.

Step 3 Go to **System > Event > Smart Event > Face Picture Comparison** to configure the face picture comparison for the camera connected to the device.

Step 4 Go to **Smart Analysis > Smart Search > Face Search** to search face pictures.

Chapter 5 Access by Web Browser

 **NOTE**

You shall acknowledge that the use of the product with Internet access might be under network security risks. For avoidance of any network attacks and information leakage, please strengthen your own protection. If the product does not work properly, please contact with your dealer or the nearest service center.

Purpose:

You can get access to the device via web browser. You may use one of the following listed web browsers: Internet Explorer 6.0 to 11.0, Apple Safari, Mozilla Firefox, and Google Chrome. The supported resolutions include 1024*768 and above.

Step 1 Open web browser, input the IP address of the device and then press Enter.

Step 2 Login to the device.

- If the device has not been activated, you need to activate the device first before login.

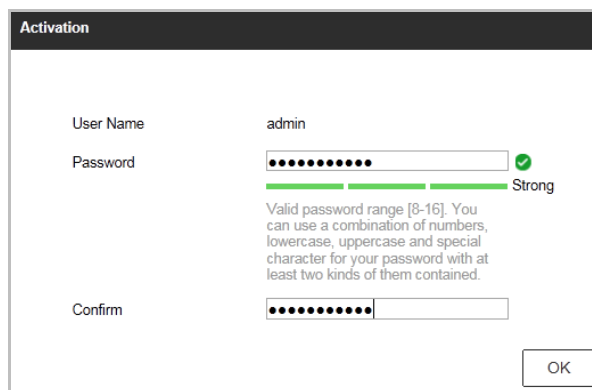

The screenshot shows a web browser window titled "Activation". It contains a form with the following fields and elements:

- User Name:** A text input field containing the text "admin".
- Password:** A password input field with a green checkmark icon to its right. Below the field is a green progress bar and the word "Strong".
- Confirm:** A second password input field for confirmation.
- Instructions:** Text below the password field reads: "Valid password range [8-16]. You can use a combination of numbers, lowercase, uppercase and special character for your password with at least two kinds of them contained."
- OK Button:** A button labeled "OK" is located at the bottom right of the form.

Figure 5-1 Set Admin Password

- 4) Set the password for the admin user account.
- 5) Click **OK** to login to the device.

 **WARNING**

STRONG PASSWORD RECOMMENDED– We highly recommend you create a strong password of your own choosing (using a minimum of 8 characters, including upper case letters, lower case letters, numbers, and special characters) in order to increase the security of your product. And we recommend you reset your password regularly, especially in the high security system, resetting the password monthly or weekly can better protect your product.

- If the device is already activated, enter the user name and password in the login interface, and click the **Login** button.

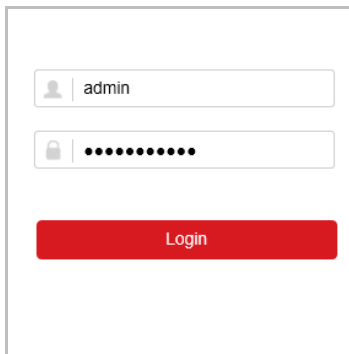

The screenshot shows a login interface with two input fields and a button. The first field is for the username, containing the text 'admin'. The second field is for the password, represented by a series of black dots. Below the fields is a prominent red button labeled 'Login'.

Figure 5-2 Login

Step 3 Install the plug-in before viewing the live video and managing the camera. Please follow the installation prompts to install the plug-in.

 **NOTE**

You may have to close the web browser to finish the installation of the plug-in.

After login, you can perform the operation and configuration of the device, including the live view, playback, log search, configuration, etc.



See Far, Go Further