

TURBO HD

TVI Dome Camera

User Manual

UD-6L0201D1931A01

Thank you for purchasing our product. If there are any questions, or requests, please do not hesitate to contact the dealer.

This manual applies to

Type	Model
Type I	DS-2CE56D1T-IRMM
Type II	DS-2CE56D1T-VPIR

This manual may contain several technical incorrect places or printing errors, and the content is subject to change without notice.

The updates will be added to the new version of this manual. We will readily improve or update the products or procedures described in the manual.

Privacy Notice

Surveillance laws vary by jurisdiction. Check all relevant laws in your jurisdiction before using this product for surveillance purposes to ensure that your use of this product conforms. Please refer to the product specification for camera parameters and functions.

Regulatory Information

FCC Information

FCC compliance: This equipment has been tested and found to comply with the limits for a digital device, pursuant to part 15 of the FCC Rules. These limits are designed to provide reasonable protection against harmful interference when the equipment is operated in a commercial environment. This equipment generates, uses, and can radiate radio frequency energy and, if not installed and used in accordance with the instruction manual, may cause harmful interference to radio communications. Operation of this equipment in a residential area is likely to cause harmful interference in which case the user will be required to correct the interference at his own expense.

FCC Conditions

This device complies with part 15 of the FCC Rules. Operation is subject to the following two conditions:

1. This device may not cause harmful interference.
2. This device must accept any interference received, including interference that may cause undesired operation.

EU Conformity Statement

This product and - if applicable - the supplied accessories too are marked with "CE" and comply therefore with the applicable harmonized European standards listed under the Low Voltage Directive 2006/95/EC, the EMC Directive 2004/108/EC, the RoHS Directive 2011/65/EU, 2012/19/EU (WEEE directive);

Products marked with this symbol cannot be disposed of as unsorted municipal waste in the European Union. For proper recycling, return this product to your local supplier upon the purchase of equivalent new equipment, or dispose of it at designated collection points. For more information see: www.recyclethis.info.

This product contains a battery that cannot be disposed of as unsorted municipal waste in the European Union.

See the product documentation for specific battery information. The battery is marked with this symbol, which may include lettering to indicate cadmium (Cd), lead (Pb), or mercury (Hg). For proper recycling, return the battery to your supplier or to a designated collection point. For more information see: www.recyclethis.info.

1 Introduction

1.1 Product Features

- This series of camera adopts new generation sensor with high sensitivity and advanced circuit design technology. It features high resolution, low image distortion and low noise, etc., which makes it suitable for surveillance system and image processing system.
- High performance CMOS sensor and high resolution bring high-quality image;
 - Low illumination;
 - OSD menu, parameters are configurable;
 - Support auto white balance, auto gain control,
 - Support image effect adjustment;
 - Unit transmission control;
 - Advanced 3-axis design meets different installation requirements.

1.2 Overview

1.2.1 Overview of Type I Camera

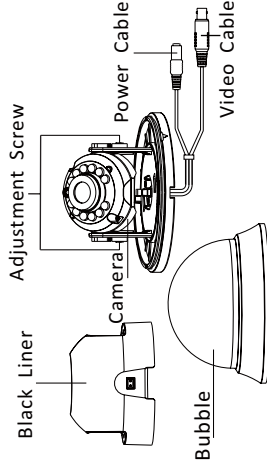

1.2.2 Overview of Type II Camera

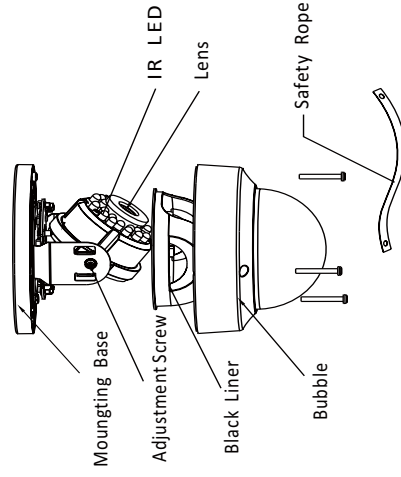

2 Installation

Before you start:

- Please make sure that the device in the package is in good condition and all the assembly parts are included.
- Make sure that all the related equipment is power-off during the installation.
- Check the specification of the products for the installation environment.
- Check whether the power supply is matched with your power output to avoid damage.
- Please make sure the wall is strong enough to withstand three times the weight of the camera and the mounting.
- If the wall is the cement wall, you need to insert expansion screws before you install the camera. If the wall is the wooden wall, you can use self-tapping screw to secure the camera.
- If the product does not function properly, please contact your dealer or the nearest service center. Do not disassemble the camera for repair or maintenance by yourself.

2.1 Installation of Type I Camera

Steps:

1. Pry the snap joint up to remove the bubble and the black liner.

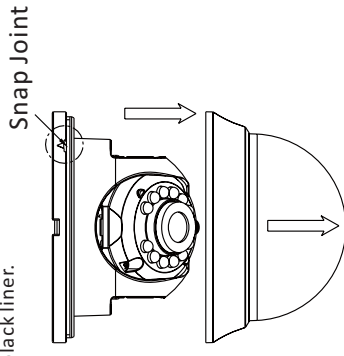

Figure 2-1 Remove the Bubble

2. Drill the screw holes and cable hole according to the drill template.

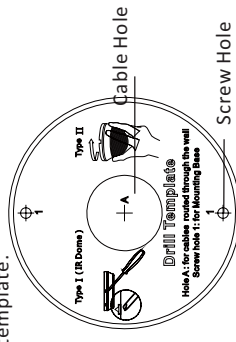

Figure 2-2 The Drill Template

3. Align the base plate with the mounting template and secure it with supplied self-tapping screws.

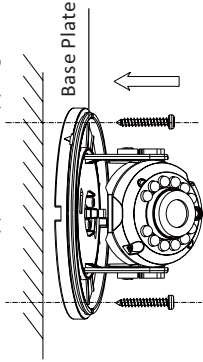

Figure 2-3 Fix the Camera to the Ceiling

4. Route the cables through the cable hole.

5. Connect the corresponding cables.

6. Adjust the camera according to the figure below to get an optimum angle.

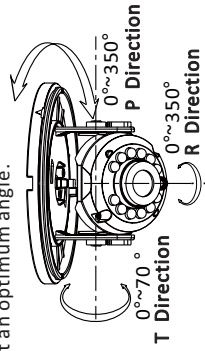

Figure 2-4 3-axis Adjustment

8. Push the black liner and buckle them upon to secure them on the camera.

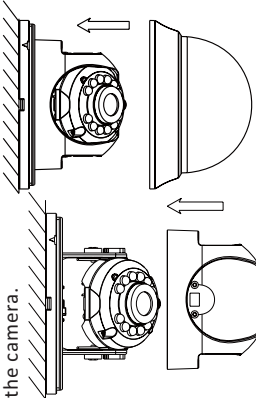

Figure 2-5 Complete the Installation

Rotate the bubble after completing the Installation may change the position of the lens.

2.2 Installation of Type II Camera

1. Loosen the screws on the bubble to remove the bubble and the black liner.

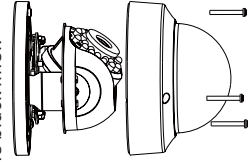

Figure 2-6 Remove the Bubble

2. Drill the screw holes and cable hole on the ceiling according to the supplied drill template.

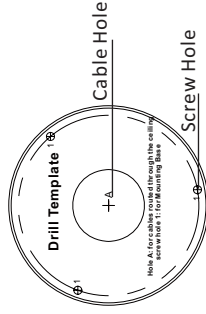

Figure 2-7 Drill Template

3. Align the base plate with the mounting template and secure it with supplied self-tapping screws.

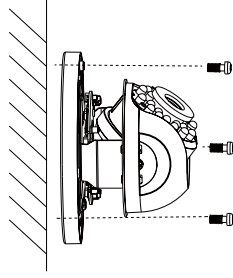

Figure 2-8 Fix the Camera to the Ceiling

4. Route the cables through the cable hole.

5. Connect the corresponding cables.

6. Adjust the camera according to the figure below to get an optimum angle.

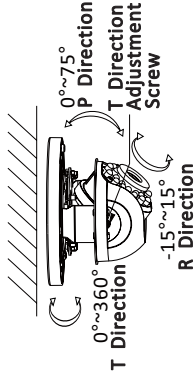

Figure 2-9 3-axis Adjustment

8. Fit the black liner and bubble on the camera.

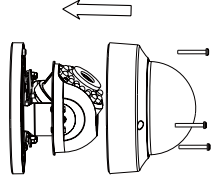

Figure 2-10 Complete the Installation

3 Menu Operation

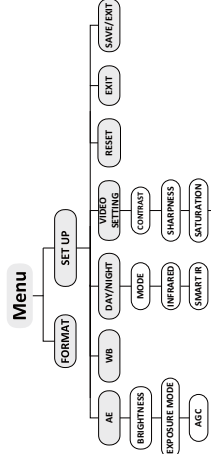

Figure 3-1 Main Menu

With a coaxial camera controller (purchase separately) or calling the preset No.95 you can select the menu and adjust the camera parameters.

3.1 FORMAT

You can set the format as PAL/NTSC.

3.2 SET UP

Move the cursor to **SET UP**, and press menu button to enter the SET UP sub menu.

3.2.1 AE

Move the cursor to AE, and you can adjust the image brightness by the **BRIGHTNESS, EXPOSURE MODE**, and **AGC**.

Brightness:

Brightness refers to the brightness of the image.

Exposure Mode:

Move the cursor to **Exposure Mode**, you can select the exposure mode between **Globe** and **BLC**.

When **BLC** is selected as the exposure mode, the level of **BLC** mode can be adjusted, as shown in the Figure 3-2.

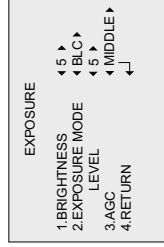

Figure 3-2 EXPOSURE

AGC:

AGC optimizes the clarity of image in poor light scene. AGC level can be set as OFF, LOW, MIDDLE and HIGH.

3.2.2 WB

Move the cursor to WB, and you can set White Balance mode as **AWB** and **MWB** in this menu.

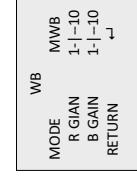

Figure 3-3 WB

AWB: white balance is being adjusted automatically.

MWB: Set the **R GAIN/B GAIN** value from 1 to 10. As shown in Figure 3-3.

3.2.3 DAY & NIGHT

Move the cursor to **DAY & NIGHT**, and select **COLOR, B/W**, or **SMART** as the **DAY & NIGHT** mode. **COLOR:** The image is colored in day mode all the time.

B/W: The image is black & white all the time, and the IR LED turns on in the low-light conditions.

SMART: Select to turn on/off the **INFRARED_LAMP** and to set the Smart IR level from 1 to 16. As shown in Figure 3-4.

	DAY/NIGHT
MODE	SMART
INFRARED	OFF
SMART IR	0-16
RETURN	↵

Figure 3-4 DAY/NIGHT

3.2.4 VIDEO SETTING

Contrast:

Contrast enhances the difference in color and light between parts of an image.

You can set the value from 1 to 10.

Sharpness:

Sharpness determines the amount of detail that an imaging system can reproduce.

You can set the value from 1 to 10.

Saturation:

You can set the saturation level of the image. The value is from 0 to 10.

DNR:

DNR decreases the noise effect, especially in low light conditions and delivers more accurate and sharp image quality. You can set the value from 0 to 7.

Mirror:

You can set the Mirror status as H, V, HV, or OFF.

3.2.5 Reset

Reset all the settings to the default.

3.2.6 EXIT

Exit and Save & exit are selectable.

3.2.7 SAVE/EXIT

Move the cursor to **SAVE & Exit**, and press OK to save the settings and exit the menu.