



# **TURBO HD**

## **H1T Series Dome Camera**

### User Manual

**UD03908B**

#### **User Manual**

Thank you for purchasing our product. If there are any questions, or requests, do not hesitate to contact the dealer.

This manual applies to the models below:

| Type           | Model                 |
|----------------|-----------------------|
| Type I Camera  | DS-2CE56H1T-(A)VPIT3Z |
| Type II Camera | DS-2CE56H1T-(A)ITZ    |

This manual may contain technical incorrect places or printing errors, and the content is subject to change without notice. The updates will be added to the new version of this manual. We will readily improve or update the products or procedures described in the manual.

0100001061208

## Regulatory Information

### FCC Information

Please take attention that changes or modification not expressly approved by the party responsible for compliance could void the user's authority to operate the equipment.

**FCC compliance:** This equipment has been tested and found to comply with the limits for a Class A digital device, pursuant to part 15 of the FCC Rules. These limits are designed to provide reasonable protection against harmful interference when the equipment is operated in a commercial environment. This equipment generates, uses, and can radiate radio frequency energy and, if not installed and used in accordance with the instruction manual, may cause harmful interference to radio communications. Operation of this equipment in a residential area is likely to cause harmful interference in which case the user will be required to correct the interference at his own expense.

### FCC Conditions

This device complies with part 15 of the FCC Rules. Operation is subject to the following two conditions:

1. This device may not cause harmful interference.
2. This device must accept any interference received, including interference that may cause undesired operation.

## EU Conformity Statement



This product and - if applicable - the supplied accessories too are marked with "CE" and comply therefore with the applicable harmonized European standards listed under the Low Voltage Directive 2014/35/EU, the EMC Directive 2014/30/EU.



2012/19/EU (WEEE directive): Products marked with this symbol cannot be disposed of as unsorted municipal waste in the European Union. For proper recycling, return this product to your local supplier upon the purchase of equivalent new equipment, or dispose of it at designated collection points. For more information see: [www.recyclethis.info](http://www.recyclethis.info).



2006/66/EC (battery directive): This product contains a battery that cannot be disposed of as unsorted municipal waste in the European Union. See the product documentation for specific battery information. The battery is marked with this symbol, which may include lettering to indicate cadmium (Cd), lead (Pb), or mercury (Hg). For proper recycling, return the battery to your supplier or to a designated collection point. For more information see: [www.recyclethis.info](http://www.recyclethis.info).

## Industry Canada ICES-003 Compliance

This device meets the CAN ICES-3 (A)/NMB-3(A) standards requirements.



### Safety Instruction

These instructions are intended to ensure that user can use the product correctly to avoid danger or property loss.

The precaution measure is divided into “Warnings” and “Cautions”

**Warnings:** Serious injury or death may occur if any of the warnings are neglected.

**Cautions:** Injury or equipment damage may occur if any of the cautions are neglected.

|   |  |
|---|--|
|  |         |
| <b>Warnings</b> Follow these safeguards to prevent serious injury or death.       | <b>Cautions</b> Follow these precautions to prevent potential injury or material damage. |



#### Warnings

- In the use of the product, you must be in strict compliance with the electrical safety regulations of the nation and region.
- Refer to technical specifications for detailed information.
- Input voltage should meet both the SELV (Safety Extra Low Voltage) and the Limited Power Source with 24 V AC or 12 V DC according to the IEC60950-1 standard. Refer to technical specifications for detailed information.
- Do not connect several devices to one power adapter as adapter overload may cause over-heating or a fire hazard.
- Make sure that the plug is firmly connected to the power socket.
- When the product is mounted on wall or ceiling, the device shall be firmly fixed.
- If smoke, odor or noise rise from the device, turn off the power at once and unplug the power cable, and then contact the service center.
- If the product does not work properly, contact your dealer or the nearest service center. Never attempt to disassemble the camera yourself. (We shall not assume any responsibility for problems caused by unauthorized repair or maintenance.)



#### Cautions

- Make sure the power supply voltage is correct before using the camera.
- Do not drop the camera or subject it to physical shock.
- Do not touch sensor modules with fingers. If cleaning is necessary, use clean cloth with a bit of ethanol and wipe it gently. If the camera will not be used for an extended period, replace the lens cap to protect the sensor from dirt.
- Do not aim the camera at the sun or extra bright places. Blooming or smearing may occur otherwise (which is not a malfunction), and affect the endurance of sensor at the same time.
- The sensor may be burned out by a laser beam, so when any laser equipment is in using, make sure that the surface of sensor will not be exposed to the laser beam.

- Do not place the camera in extremely hot, cold, dusty or damp locations, and do not expose it to high electromagnetic radiation.
- To avoid heat accumulation, good ventilation is required for operating environment.
- Keep the camera away from liquid while in use.
- While in delivery, the camera shall be packed in its original packing, or packing of the same texture.

# 1 Introduction

## 1.1 Product Features

The camera is applicable for both indoor and outdoor conditions, and the application scenarios include road, warehouse, underground parking lot, bar, etc..

The main features are as follows:

- High performance CMOS sensor
- Low illumination, 0.01 Lux@(F1.2, AGC ON), 0 Lux with IR
- IR cut filter with auto switch
- OSD menu with configurable parameters
- Auto white balance
- internal synchronization
- SMART IR mode
- 3-axis adjustment

**Note:**

Type II camera is applicable to indoor only.

## 1.2 Overview

**Note:**

- The cables of device vary according to different models. The cables of each type are shown in the figures below, please refer to the actual sample.
- You can debug the camera by connecting an auxiliary HD TVI cable to the auxiliary video output.

### 1.2.1 Overview of Type I Camera

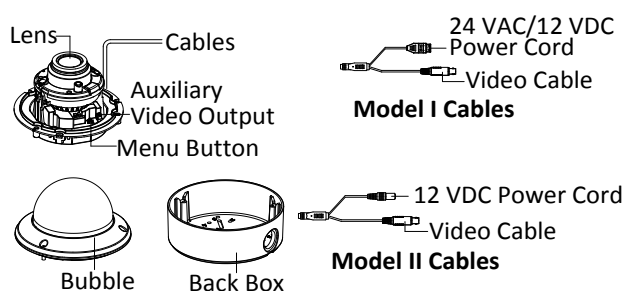

Figure 1-1 Overview of Type I Camera

### 1.2.2 Overview of Type II Camera

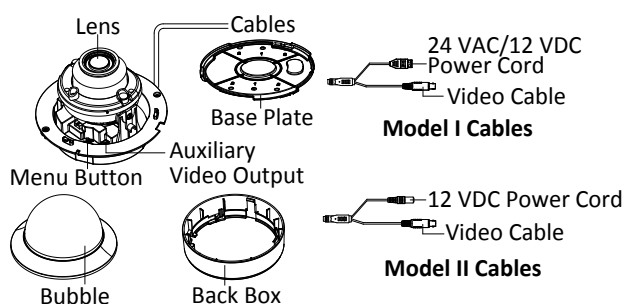

Figure 1-2 Overview of Type II Camera

# 2 Installation

**Before you start:**

- Make sure that the device in the package is in good condition and all the assembly parts are included.

- Make sure that all the related equipment is power-off during the installation.
- Check the specification of the products for the installation environment.
- Check whether the power supply is matched with your power output to avoid the damage.
- Make sure the wall is strong enough to withstand three times the weight of the camera and the bracket.
- If the wall is cement, you need to insert expansion bolts before you install the camera. If the wall is wooden, you can use self-tapping screws to secure the camera.
- If the product does not function properly, contact your dealer or the nearest service center. Do NOT disassemble the camera for repair or maintenance by yourself.

## 2.1 Ceiling Mounting

### Note:

Both wall mounting and ceiling mounting are suitable for the bullet camera. Ceiling mounting will be taken as an example in this section. And you can take steps of ceiling mounting as a reference for wall mounting.

### Steps:

1. Paste the drill template to the ceiling.
2. Drill screw holes and the cable hole (optional) on the ceiling according to the supplied drill template.

### Note:

Drill the cable hole when adopting the ceiling outlet to route the cable.

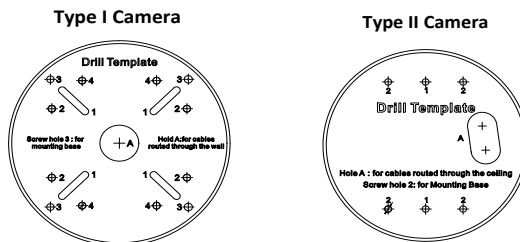

Figure 2-1 The Drill Template

3. Loosen the screws on the bubble of the dome camera to remove the bubble and the black liner.
4. Attach the back box of type I camera/base plate of type II camera to the ceiling and secure them with supplied screws.

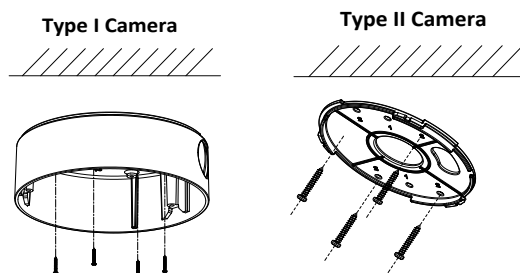

Figure 2-2 Attach the Back Box/Base Plate

**Note:**

- In the supplied screw package, both self-tapping screws and expansion bolts are contained.
  - For cement ceiling, expansion bolts are required to fix the camera. For wooden ceiling, self-tapping screws are required.
5. Route the cables through the cable hole, or the side opening.
  6. Align the camera with the back box/base plate, and tighten the screws to secure the camera with the back box/base plate.

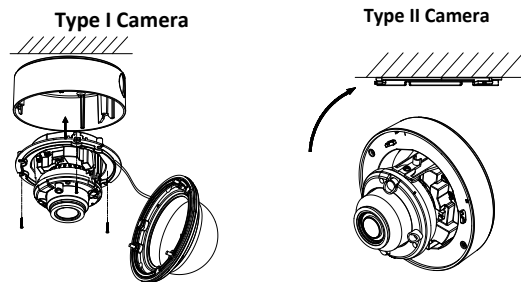

Figure 2-3 Fix the camera to the Ceiling

7. Connect the corresponding cables, such as power cable and video cable.
8. Power on the camera to check whether the image on the monitor is gotten from the optimum angle. If not, adjust the camera according to the figure below to get an optimum angle.

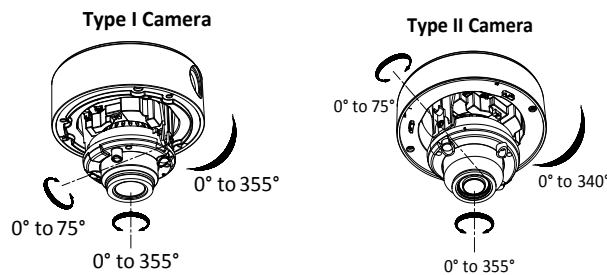

Figure 2-4 3-Axis Adjustment

9. Fit the black liner back to the camera and tighten the screws on the bubble of the dome camera to finish the installation.

## 2.2 Wall Mounting

**Note:**

You need to purchase a wall mounting bracket separately.

**Steps:**

1. Drill 4 screw holes in the wall according to the holes of the bracket.
2. Attach the bracket to the wall by aligning the 4 screw holes of the bracket with expansion screws on the wall.
3. Secure the bracket with 4 hex nuts and washers.

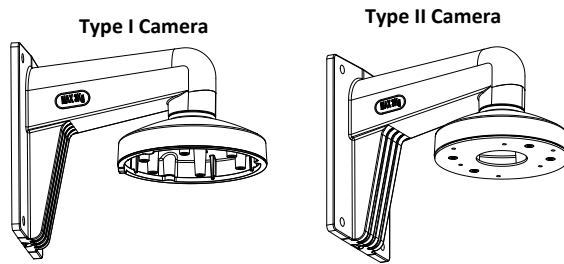

Figure 2-5 Install Wall Mounting Bracket

4. Refer to step 3 of 2.1 *Ceiling Mounting* to remove dome camera's bubble and the black liner.
5. Attach the back box/base plate of the dome camera to the wall mounting bracket and secure them with supplied screws.

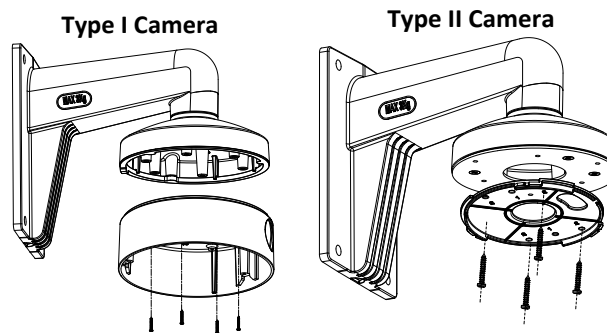

Figure 2-6 Attach the Base Plate to the Bracket

6. Route the cables through the bracket.
7. Repeat steps 6 to 9 of the 2.1 *Ceiling Mounting* to complete the installation.

### 2.3 In-Ceiling Mounting

**Note:**

You need to purchase an in-ceiling mounting bracket separately.

**Steps:**

1. Attach the drill template on the ceiling.
2. Drill the screw holes and cable holes (optional) in the ceiling according to the supplied drill template.

**Note:**

Drill the cable hole when adopting the ceiling outlet to route the cable.

3. Screw the bolts through the mounting bracket by aligning with the 2 bolt holes. Fit the toggles onto the bolts.
4. Push the two bolts through the two screw holes in the ceiling. Rotate the bolt till the toggle holds the ceiling tightly.

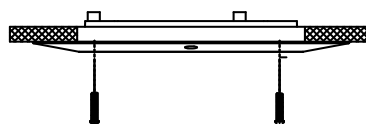

Figure 2-7 Install the In-Ceiling Mounting Bracket

5. Route the cables through the cable hole.
6. Fix the camera to the in-ceiling mounting bracket with the supplied screws.



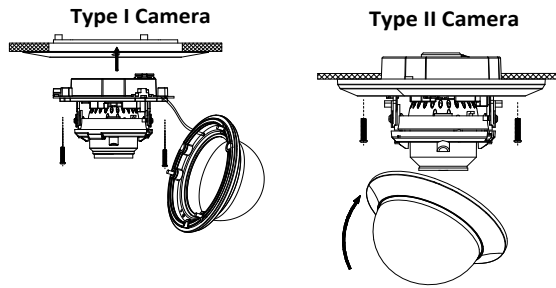

Figure 2-8 Fix the Camera to the Mount

7. Connect the corresponding cables, such as power cord, and video cable.
8. Repeat steps 8 to 9 of the *2.1 Ceiling Mounting* to complete the installation.

### 2.4 Mounting with Inclined Base of Type I Camera

**Steps:**

1. Drill 4 screw holes and the cable hole in the ceiling according to the holes of the inclined base.
2. Install the inclined base to the ceiling with supplied screws, as shown in Figure 2-9.

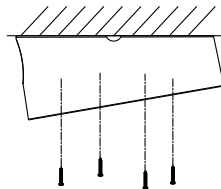

Figure 2-9 Fix the Inclined Base

3. Route the cables through the cable hole, or the side opening of the inclined base.
4. Fix the camera to the inclined base with the supplied screws.

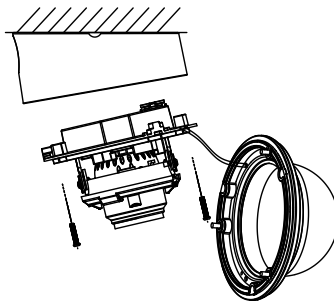



Figure 2-10 Fix the Camera to the Base

5. Repeat the steps 7 to 9 of the *2.1 Ceiling Mounting* section to complete the installation.

## 3 Menu Description

**Purpose:**

Call the menu by clicking button  on the PTZ interface, or call preset No.95.

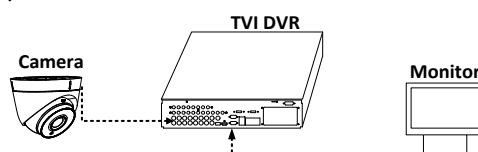



Figure 3-1 Connection

**Steps:**

1. Connect the camera with the TVI DVR, and the monitor shown as the Figure 3-1.
2. Power on the analog camera, TVI DVR, and the monitor to view the image on the monitor.
3. Click PTZ Control to enter the PTZ Control interface.
4. Call the camera menu by clicking  button, or call preset No. 95.
5. Click the direction arrow to control the camera.
  - (1) Click up/down direction button to select the item.
  - (2) Click Iris + to confirm the selection.
  - (3) Click left/right direction button to adjust the value of the selected item.

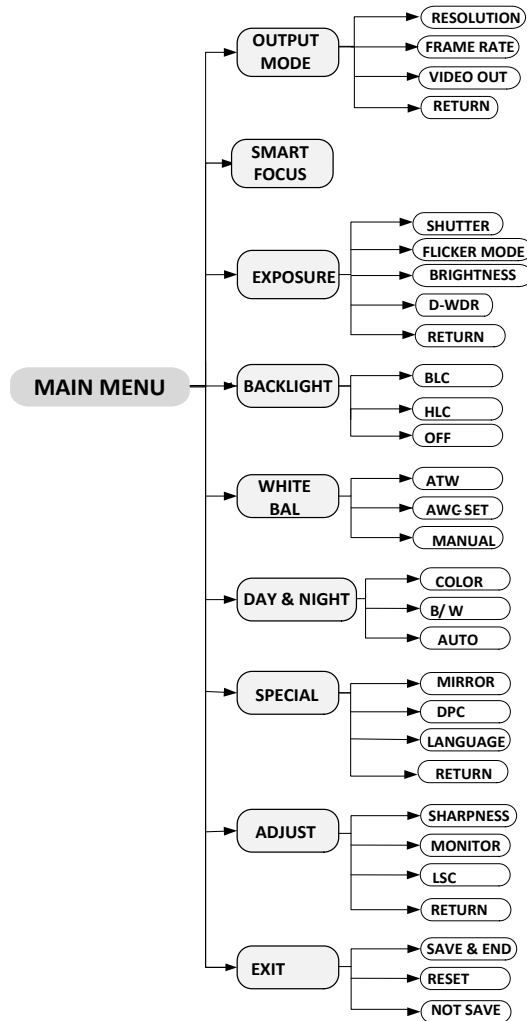

Figure 3-2 Main Menu Overview

**3.1 OUTPUT MODE**

In the OUTPUT MODE submenu, you can set RESOLUTION, FRAME RATE, and VIDEO OUT.

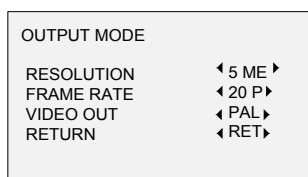

Figure 3-3 AE

## RESOLUTION

Resolution refers to the number of the pixels can be displayed on the image. You can set the resolution as 5 megapixels or 4 megapixels. The higher the value, the finer the image is.

## FRAME RATE

Frame rate refers to the number of image output in 1 second.

When the resolution is set as 5 megapixels, you are allowed to set the frame rate as 20 fps or 12.5 fps.

When the resolution is set as 4 megapixels, you are allowed to set the frame rate as 25 fps or 30 fps.

## VIDEO OUT

### PAL

(Phase Alternating Lines) is a color encoding system for analog television used in broadcast television systems in most countries.

### NTSC

(National Television System Committee) is the analog television system that is used in most of North America, parts of South America, Myanmar, South Korea, etc..

## 3.2 SMART FOCUS

You are allowed to adjust the focus by clicking FOCUS+, or FOCUS-, and adjust zoom ration by click ZOOM+, or ZOOM-.

## 3.3 EXPOSURE

Exposure describes the brightness-related parameters.

You can adjust the image brightness by the **SHUTTER FLICKER MODE, AGC, BRIGHTNESS, and D-WDR** in different light conditions.

| EXPOSURE    |          |
|-------------|----------|
| SHUTTER     | ◀ AUTO ▶ |
| FLICKER MOD | ◀ OFF ▶  |
| AGC         | ◀ 10 ▶   |
| BRIGHTNESS  | ◀ 37 ▶   |
| D-WDR       | ◀ AUTO ▶ |
| RETURN      | ◀ RET ▶  |

Figure 3-4 EXPOSURE

### SHUTTER

Shutter denotes the speed of the shutter.

**PAL:** AUTO, 1/25 s, 1/50 s, FLK, 1/200 s, 1/400 s, 1/1k s, 1/2k s, 1/5k s, 1/10k s, and 1/50k s are selectable.

**NTSC:** AUTO, 1/30s, 1/60s, FLK, 1/240s, 1/480s, 1/1k s, 1/2k s, 1/5k s, 1/10k s, and 1/50k s are selectable.

### FLICKER MODE

Set the Flick Mode as ON to prevent the image from flicker when the video out is not compatible.

### AGC

It's a form of amplification where the camera will automatically boost the image output signal to optimize the clarity of image in poor light conditions. You can set the AGC value from 0 to 15. The AGC is disabled if the value is set to 0.

## **BRIGHTNESS**

Brightness refers to the brightness of the image. You can set the brightness value from 1 to 10 to darken or brighten the image. The higher the value is, the brighter the image is.

## **D-WDR**

The digital wide dynamic range helps the camera provide clear images even under backlight circumstances. When there are both very bright and very dark areas simultaneously in the field of view, D-WDR balances the brightness level of the whole image and provide clear images with details.

Set the D-WDR as ON to improve the image quality under the backlight environment.

Set the D-WDR as OFF to disable the function.

## **3.4 BACKLIGHT**

Backlight is applicable for the backlight or the high luminance environment. You can set the Backlight to BLC, and HLC.

### **BLC**

Backlight Compensation: If there's a strong backlight, the object in front of the backlight will appear silhouetted or dark. Based on the back area, BLC enhances the brightness of the whole image, which makes it possible to see the area in the strong backlight clearly, but the backlight area will be over-exposed.

### **HLC**

High Light Compensation: Masks strong light sources that usually flare across a scene. This makes it possible to see the detail of the image that would normally be hidden.

## **3.5 WB (White Balance)**

White balance is the white rendition function of the camera to adjust the color temperature according to the environment. It can remove the unrealistic color casts in the image.

**MANUAL, ATW** (Auto-Tracking White Balance), **AWC→SET** are selectable.

### **MANUAL**

You can set the R GAIN/B GAIN value from 0 to 255 to adjust the shades of red/blue color of the image.

### **ATW**

In **ATW** mode, white balance is being adjusted automatically according to the color temperature of the scene illumination.

### **AWC→SET**

Similar with ATW, the white balance is continuously being adjusted in real-time according the scene if AWC→SET is selected, however, if the scene changed, you have to go to AWC→SET to get another proper white balance for the new scene.

## **3.6 DAY & NIGHT**

Color, B/W, and Auto are selectable for DAY & NIGHT switch.

**COLOR:** the image is colored in day mode all the time.

**B/W:** the image is black and white all the time, and the IR LED turns on in the low-light conditions.

**AUTO:** The image switches from color to B/W or from B/W to color automatically according to the light condition. And you can select to turn on or turn off the IR LED according to different illuminations.

### 3.7 SPECIAL

In the SPECIAL sub-menu, you can set the MIRROR, DPC (Defective Point Correction), and LANGUAGE.

#### MIRROR

**OFF, H-FLIP, V-FLIP, and RORATE**

**OFF:** The mirror function is disabled.

**H-FLIP:** The image flips 180 degree horizontally.

**V-FLIP:** The image flips 180 degree vertically.

**ROTATE:** The image flips 180 degree both horizontally and vertically.

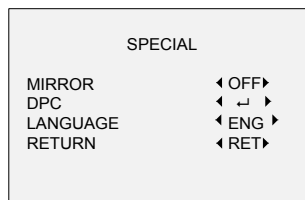

Figure 3-5 SPECIAL

#### DPC

Defective pixels are pixels in a CCD or CMOS image sensor in digital cameras, in which the defective pixels fail to sense light levels correctly. This series of camera supports defective pixel correction. Move the cursor to DCP and click Iris+ to enter the defective pixel correction interface. LIVE DPC, WHITE DPC and BLACK DPC are adjustable in this section.

**LIVE DPC:** Detects and corrects the dynamic or the real-time defective pixels occur during the using. ON, and OFF are selectable. The correction level from 0 to 255 is configurable if the LIVE DPC is set as ON, set it as OFF to disable the live defective pixel correction.

**WHITE DPC:** White DPC is the pixel on CCD or CMOS sensor that appear completely white. Move the cursor to the white DPC, and press **Iris+** to enter the white DPC configuration interface.

**BLACK DPC:** Black DPC is the pixel on CCD or CMOS sensor that appear completely black. Move the cursor to the white DPC, and press **Iris+** to enter the black DPC configuration interface.

#### LANGUAGE

Supports English, and Chinese.

### 3.8 ADJUST

In the **ADJUST** sub-menu, you can configure the settings, including the sharpness, monitor, and the LSC (lens shading compensation). Move the cursor to **ADJUST** and click **Iris +** to enter the adjust configuration interface.

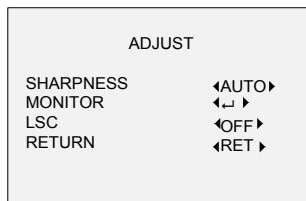

Figure 3-6 ADJUST

### SHARPNESS

Sharpness determines the amount of detail an imaging system can reproduce. And you can adjust the sharpness from 0 to 15. The higher the value, the clearer and sharper the image appears.

### MONITOR

**GAMMA**, **BLUE GAIN**, and **RED GAIN** are selectable.

**GAMMA** is the name of a nonlinear operation used to code and decode luminance or tristimulus values in video or still image system, with USER, 0.45, 0.50, 0.55, 0.60, 0.65, 0.70, 0.75, 0.80, 0.85, 0.90, 0.95, and 1.00 are selectable.

**BLUE GAIN** can be adjusted from 0 to 100.

**RED GAIN** Can be adjusted from 0 to 100.

### LSC

Lens shading correction corrects the phenomenon that the image gets darkened or blurred on the periphery.

Set it as ON, move the cursor to **SCAN** and click Iris+ to correct the lens shading. Set it as OFF to disable the LSC.

### 3.9 EXIT

#### RESET

Move the cursor to **RESET** and click Iris+ to reset all the settings to the default.

#### NOT SAVE

Move the cursor to **NOT SAVE** and click Iris+ to exit the menu without saving the settings

#### SAVE & END

Move the cursor to **SAVE & END** and click Iris+ to save the setting and exit the menu.