

Digital VTH
(Version 4.0)
User's Manual

V1.0.1

Cybersecurity Recommendations

Mandatory actions to be taken towards cybersecurity

1. Change Passwords and Use Strong Passwords:

The number one reason systems get “hacked” is due to having weak or default passwords. It is recommended to change default passwords immediately and choose a strong password whenever possible. A strong password should be made up of at least 8 characters and a combination of special characters, numbers, and upper and lower case letters.

2. Update Firmware

As is standard procedure in the tech-industry, we recommend keeping NVR, DVR, and IP camera firmware up-to-date to ensure the system is current with the latest security patches and fixes.

“Nice to have” recommendations to improve your network security

1. Change Passwords Regularly

Regularly change the credentials to your devices to help ensure that only authorized users are able to access the system.

2. Change Default HTTP and TCP Ports:

- Change default HTTP and TCP ports for systems. These are the two ports used to communicate and to view video feeds remotely.
- These ports can be changed to any set of numbers between 1025-65535. Avoiding the default ports reduces the risk of outsiders being able to guess which ports you are using.

3. Enable HTTPS/SSL:

Set up an SSL Certificate to enable HTTPS. This will encrypt all communication between your devices and recorder.

4. Enable IP Filter:

Enabling your IP filter will prevent everyone, except those with specified IP addresses, from accessing the system.

5. Change ONVIF Password:

On older IP Camera firmware, the ONVIF password does not change when you change the system’s credentials. You will need to either update the camera’s firmware to the latest revision or manually change the ONVIF password.

6. Forward Only Ports You Need:

- Only forward the HTTP and TCP ports that you need to use. Do not forward a huge range of numbers to the device. Do not DMZ the device's IP address.
- You do not need to forward any ports for individual cameras if they are all connected to a recorder on site; just the NVR is needed.

7. Disable Auto-Login on SmartPSS:

Those using SmartPSS to view their system and on a computer that is used by multiple people should disable auto-login. This adds a layer of security to prevent users without the appropriate credentials from accessing the system.

8. Use a Different Username and Password for SmartPSS:

In the event that your social media, bank, email, etc. account is compromised, you would not want someone collecting those passwords and trying them out on your video surveillance system. Using a different username and password for your security system will make it more difficult for someone to guess their way into your system.

9. Limit Features of Guest Accounts:

If your system is set up for multiple users, ensure that each user only has rights to features and functions they need to use to perform their job.

10. UPnP:

- UPnP will automatically try to forward ports in your router or modem. Normally this would be a good thing. However, if your system automatically forwards the ports and you leave the credentials defaulted, you may end up with unwanted visitors.
- If you manually forwarded the HTTP and TCP ports in your router/modem, this feature should be turned off regardless. Disabling UPnP is recommended when the function is not used in real applications.

11. SNMP:

Disable SNMP if you are not using it. If you are using SNMP, you should do so only temporarily, for tracing and testing purposes only.

12. Multicast:

Multicast is used to share video streams between two recorders. Currently there are no known issues involving Multicast, but if you are not using this feature, deactivation can enhance your network security.

13. Check the Log:

If you suspect that someone has gained unauthorized access to your system, you can check the system log. The system log will show you which IP addresses were used to login to your system and what was accessed.

14. Physically Lock Down the Device:

Ideally, you want to prevent any unauthorized physical access to your system. The best way to achieve this is to install the recorder in a lockbox, locking server rack, or in a room that is behind a lock and key.

15. Connect IP Cameras to the PoE Ports on the Back of an NVR:

Cameras connected to the PoE ports on the back of an NVR are isolated from the outside world and cannot be accessed directly.

16. Isolate NVR and IP Camera Network

The network your NVR and IP camera resides on should not be the same network as your public computer network. This will prevent any visitors or unwanted guests from getting access to the same network the security system needs in order to function properly.

General

This document mainly introduces function, structure, network, installation process, debugging process of VTH products matched with Version 4.0 VT UI interface, together with operating instruction and technical parameter of UI interface.

Models





Type	Model Series	Specific Model	
Digital VTH	VTH5221 series	VTH5221DW, VTH5221D, VTH5221DW-C, VTH5221D-C, VTH5221D-CW, VTH5221DW-W, VTH5221DW-CW	
	VTH5241 series	VTH5241D, VTH5241DW, VTH5241DW-C, VTH5241D-C, VTH5241D-CW, VTH5241DW-W, VTH5241DW-CW	
	VTH15 series	Type A	VTH1510A, VTH1520A, VTH1520AS-H, VTH1510AH, VTH1520AH, VTH1520AS
		Type B	VTH1550B, VTH1560B(W)
		Type CH	VTH1510CH, VTH1520CH, VTH1550CH
	VTH16 series	VTH1660CH	
VTH2X series	VTH2221A		
2-wire VTH		VTH5222H	

Device Upgrade

Please don't cut off power supply during upgrade. Power can be cut only after the device completes upgrade and reboots.

Safety Instructions

The following categorized signal words with defined meaning might appear in the Manual.

Signal Words	Meaning
 DANGER	Indicates a high potential hazard which, if not avoided, will result in death or serious injury.
 WARNING	Indicates a medium or low potential hazard which, if not avoided, could result in slight or moderate injury.
 CAUTION	Indicates a potential risk which, if not avoided, could result in property damage, data loss, lower performance, or unpredictable result.
 TIPS	Provides methods to help you solve a problem or save you time.

 NOTE	Provides additional information as the emphasis and supplement to the text.
--	---

Revision History

No.	Version	Revision Content	Release Date
1	V1.0.0	First release	2017.11.1
2	V1.0.1	Add privacy protection notice	2018.05.23

Privacy Protection Notice

As the device user or data controller, you might collect personal data of others' such as face, fingerprints, car plate number, Email address, phone number, GPS and so on. You need to be in compliance with the local privacy protection laws and regulations to protect the legitimate rights and interests of other people by implementing measures include but not limited to: providing clear and visible identification to inform data subject the existence of surveillance area and providing related contact.

About the Manual

- The Manual is for reference only. If there is inconsistency between the Manual and the actual product, the actual product shall prevail.
- We are not liable for any loss caused by the operations that do not comply with the Manual.
- The Manual would be updated according to the latest laws and regulations of related regions. For detailed information, see the paper User's Manual, CD-ROM, QR code or our official website. If there is inconsistency between paper User's Manual and the electronic version, the electronic version shall prevail.
- All the designs and software are subject to change without prior written notice. The product updates might cause some differences between the actual product and the Manual. Please contact the customer service for the latest program and supplementary documentation.
- There still might be deviation in technical data, functions and operations description, or errors in print. If there is any doubt or dispute, please refer to our final explanation.
- Upgrade the reader software or try other mainstream reader software if the Guide (in PDF format) cannot be opened.
- All trademarks, registered trademarks and the company names in the Manual are the properties of their respective owners.
- Please visit our website, contact the supplier or customer service if there is any problem occurred when using the device.
- If there is any uncertainty or controversy, please refer to our final explanation.

Important Safeguards and Warnings

The following description is the correct application method of the device. Please read the manual carefully before use, in order to prevent danger and property loss. Strictly conform to the manual during application and keep it properly after reading.

Operating Requirement

- Please modify the default password after deployment, to avoid being stolen.
- Please don't place and install the device in an area exposed to direct sunlight or near heat generating device.
- Please don't install the device in a humid, dusty or fuliginous area.
- Please keep its horizontal installation, or install it at stable places, and prevent it from falling.
- Please don't drip or splash liquids onto the device; don't put on the device anything filled with liquids, in order to prevent liquids from flowing into the device.
- Please install the device at well-ventilated places; don't block its ventilation opening.
- Use the device only within rated input and output range.
- Please don't dismantle the device arbitrarily.

Power Requirement

- The product shall use electric wires (power wires) recommended by this area, which shall be used within its rated specification.
- Please use power supply that meets SELV (safety extra low voltage) requirements, and supply power with rated voltage that conforms to Limited Power Source in IEC60950-1. For specific power supply requirements, please refer to device labels.
- If power plug or appliance coupler is a disconnecting device, during normal use, please keep an angle that facilitates operation.

Table of Contents

Cybersecurity Recommendations	II
Foreword	V
Important Safeguards and Warnings	VII
1 Product Overview	1
1.1 Product Profile	1
1.2 Product Function	1
2 Product Structure	3
2.1 Front Panel	3
2.1.1 VTH5221 Series /VTH5241 Series.....	3
2.1.2 VTH15 Series Type A/B	4
2.1.3 VTH15 Series Type CH/5222H	6
2.1.4 VTH1660CH.....	7
2.1.5 VTH2221A.....	7
2.2 Rear Panel Port.....	9
2.2.1 VTH5221 Series/VTH5241 Series.....	9
2.2.2 VTH15 Series Type A/ Type B/ Type CH	9
2.2.3 VTH5222CH/VTH1550CHW-2.....	10
2.2.4 VTH1660CH.....	11
2.2.5 VTH2221A.....	12
3 Network Diagram	14
3.1 2-wire System.....	14
3.2 Digital System.....	15
4 Device Installation	17
4.1 Installation Flow Chart.....	17
4.2 Open-case Inspection	17
4.3 Installation Requirement	18
4.4 Device Installation.....	18
4.4.1 Surface Installation	18
4.4.2 Installation with 86 Box.....	19
5 Device Debugging	20
5.1 Debugging Settings	20
5.1.1 VTO Settings.....	20
5.1.2 VTH Config.....	25
5.2 Debugging Verification	30
5.2.1 VTO Calls VTH	30
5.2.2 VTH Monitors VTO.....	30
6 Interface Operation	32
6.1 Main Interface.....	32
6.2 Setting.....	33
6.2.1 Ring Settings.....	33
6.2.2 DND Settings	37

6.2.3 Alarm Setting.....	38
6.2.4 Mode Setting.....	42
6.2.5 General Setting.....	43
6.2.6 Product Info.....	49
6.3 Project Settings	50
6.3.1 Forget Password	50
6.3.2 Network Settings	51
6.3.3 VTH Config.....	54
6.3.4 VTO Config	55
6.3.5 Search Device	56
6.3.6 Default.....	58
6.3.7 Reset MSG.....	59
6.4 Call	59
6.4.1 Contact	59
6.4.2 Call User.....	61
6.4.3 Call from User.....	63
6.4.4 Call from VTO	64
6.4.5 Call Log.....	66
6.5 Monitor.....	66
6.5.1 Monitoring of VTO	67
6.5.2 Monitoring of IPC	69
6.5.3 Favorite.....	72
6.6 SOS.....	72
6.7 Info	73
6.7.1 Alarm	73
6.7.2 Guest Message	74
6.7.3 Publish Info	75
6.7.4 Video Pic	76
6.8 Unlock Function.....	76
6.9 Arm and Disarm Function	76
6.9.1 Arm	76
6.9.2 Disarm.....	77
Appendix 1 Technical Parameters.....	79
Appendix 1.1 VTH5221D Series /VTH5241D Series	79
Appendix 1.2 VTH5222H Series.....	79
Appendix 1.3 VTH15 Series Type A/B/CH	80
Appendix 1.4 VTH16 Series	81
Appendix 1.5 VTH2221A Series	81

1.1 Product Profile

VTH series product is a digital video intercom home station for numerous homes, integrating monitoring, intercom and unlocking. With embedded technology, all IP network, SNMP (Simple Network Management Protocol) network management technology and network encryption technology, achieve more stable system operation, richer functional extension, more convenient system management and safer data transmission.

1.2 Product Function

Wi-Fi Networking

Realize Wi-Fi networking of devices.

Video Intercom

Call or connect VTO and VTH; realize talk.

Monitoring

Monitor fence station, VTO and IPC devices.

SOS

Press the key to call the Call Center in case of an emergency.

Auto Snapshot

Snapshot the call picture or monitoring picture, and store them in SD card or FTP.

DND (Do Not Disturb)

Avoid other's incoming call interference.

Remote Unlock

Realize remote unlock.

Arm and Disarm

Provide 6/8-channel area setting, arm and disarm them.

Playback

Play back videos and pictures in SD card of this device.

Alarm

After 8/6-channel area triggers an alarm, pop up an alarm prompt interface, provide linkage alarm output and report to Call Center.

Record Inquiry

Inquire call records and alarm records.

Message Inquiry

Inquire guests' message, videos, pictures and announcements issued by Property Management Center.

2.1 Front Panel

2.1.1 VTH5221 Series /VTH5241 Series

VTH5221D is a 7" digital indoor monitor, and VTH5241D is a 10" digital indoor monitor. Their front panels have the same size, as shown in Figure 2-1. Please refer to Table 2-1 for details.

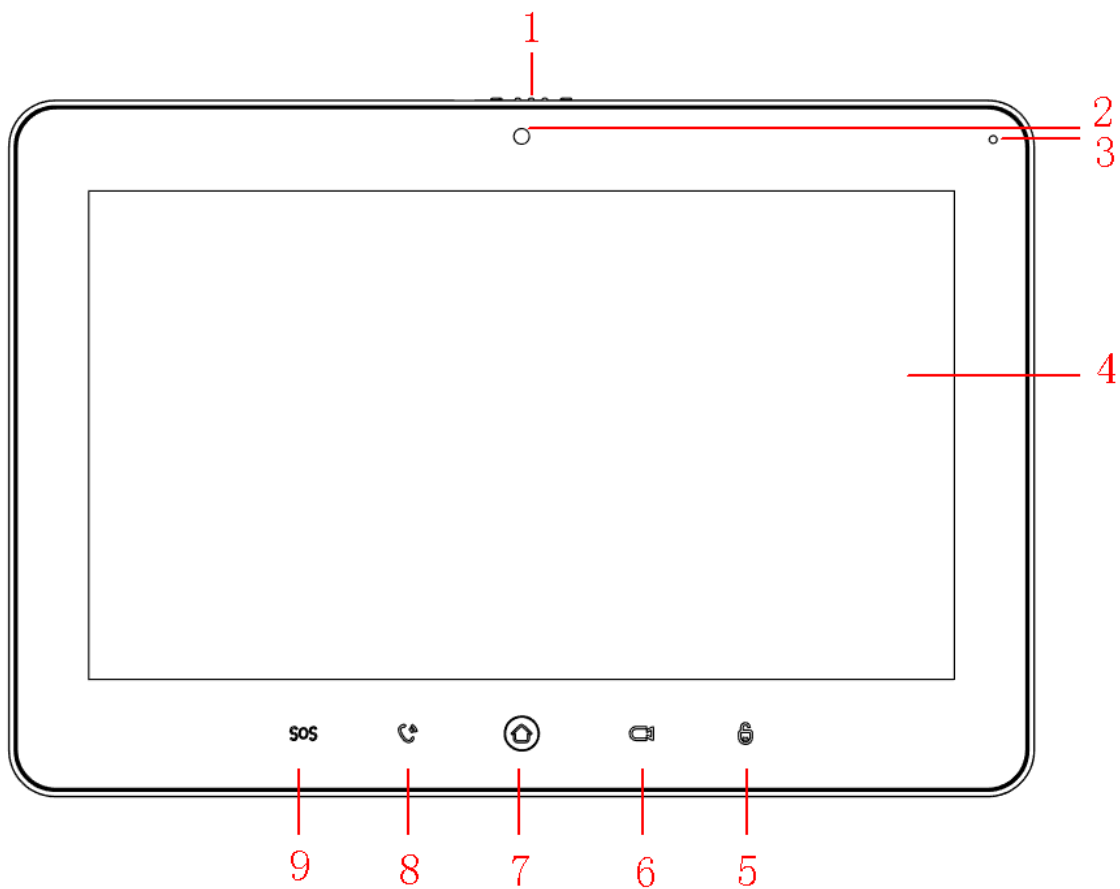

Figure 2-1

No.	Name	Description
1	Camera occlusion switch	Slide it to occlude or open the camera.
2	Camera	Only VTH5221DW-C and VTH5241DW-C support front-facing camera.
3	Microphone	Voice input.
4	Display screen	<ul style="list-style-type: none"> 7" type D digital VTH owns a 7" high-definition LCD. 10" type D digital VTH owns a 10" high-definition LCD.

No.	Name	Description
5	Unlock	Press this key during calling, talking, monitoring and speaking of VTO, so corresponding VTO will be unlocked.
6	Monitor	<ul style="list-style-type: none"> • In standby mode, press this key to monitor the main VTO. • During monitoring, press this key to exit monitoring.
7	Menu	Press this key to return to main menu.
8	Call	<ul style="list-style-type: none"> • In case of incoming call, press this key to answer the call. • During talk, press this key to hang up. • During monitoring, press this key to speak to unit VTO, villa VTO and fence station. • During speaking, press this key to exit speaking.
9	SOS	Press this key to call the Call Center in case of emergency.

Table 2-1

2.1.2 VTH15 Series Type A/B

In VTH15 series, different types of devices have different front panels.

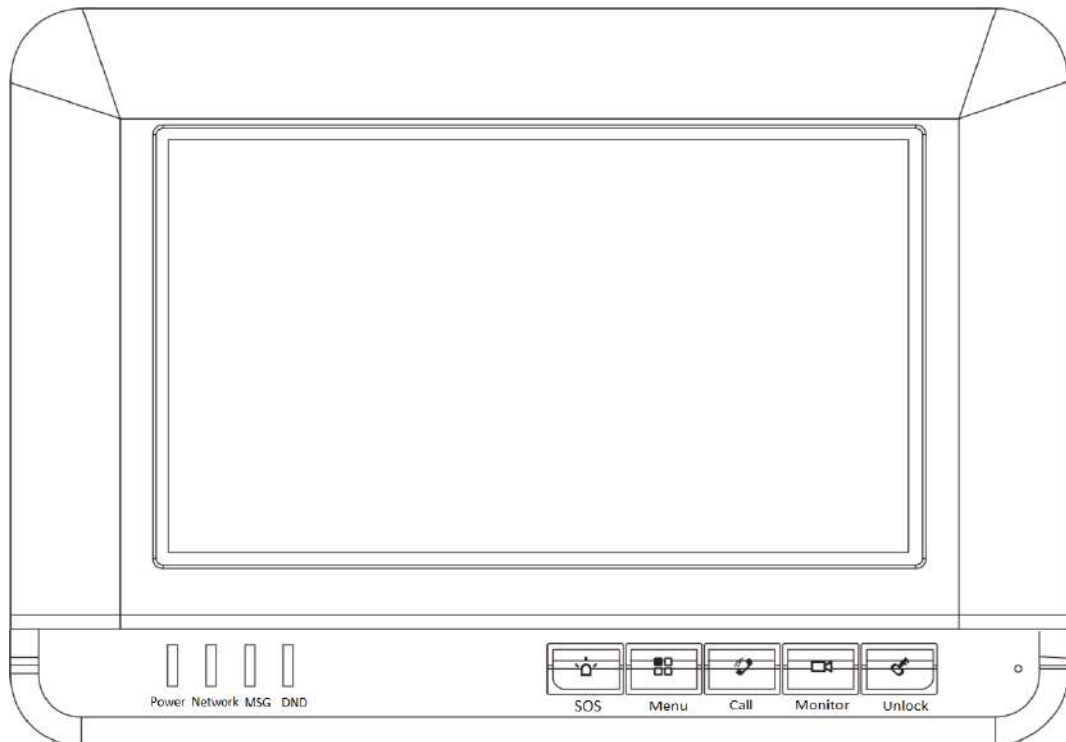





Figure 2-2 VTH15 Series Type A

Icon	Name	Description
 SOS	SOS	Press this key to call the Call Center in case of emergency.
 Menu	Menu	Press this key to return to main menu.
 Call	Call	<ul style="list-style-type: none"> • In case of incoming call, press this key to answer the call. • During talk, press this key to hang up.







Icon	Name	Description
		<ul style="list-style-type: none"> • During monitoring, press this key to speak to apartment VTO, villa VTO and fence station. • During speaking, press this key to exit speaking.
	Monitor	<ul style="list-style-type: none"> • In standby mode, press this key to monitor the main VTO. • During monitoring, press this key to exit monitoring.
	Unlock	Press this key during calling, talking, monitoring and speaking of VTO, so corresponding VTO will be unlocked.
	Power indicator	If this indicator turns on in green, it represents normal power supply.
	Network indicator	<ul style="list-style-type: none"> • If this indicator turns on, it represents normal communication with VTO. • If this indicator turns off, it represents abnormal communication with VTO.
	Message indicator	If this indicator turns on, it represents that there are unread messages.
	DND indicator	<p>If this indicator turns on in green, it represents that DND function is enabled.</p> <p> Note</p> <p>For DND settings, please refer to “6.2.2 DND Settings”.</p>

Table 2-2

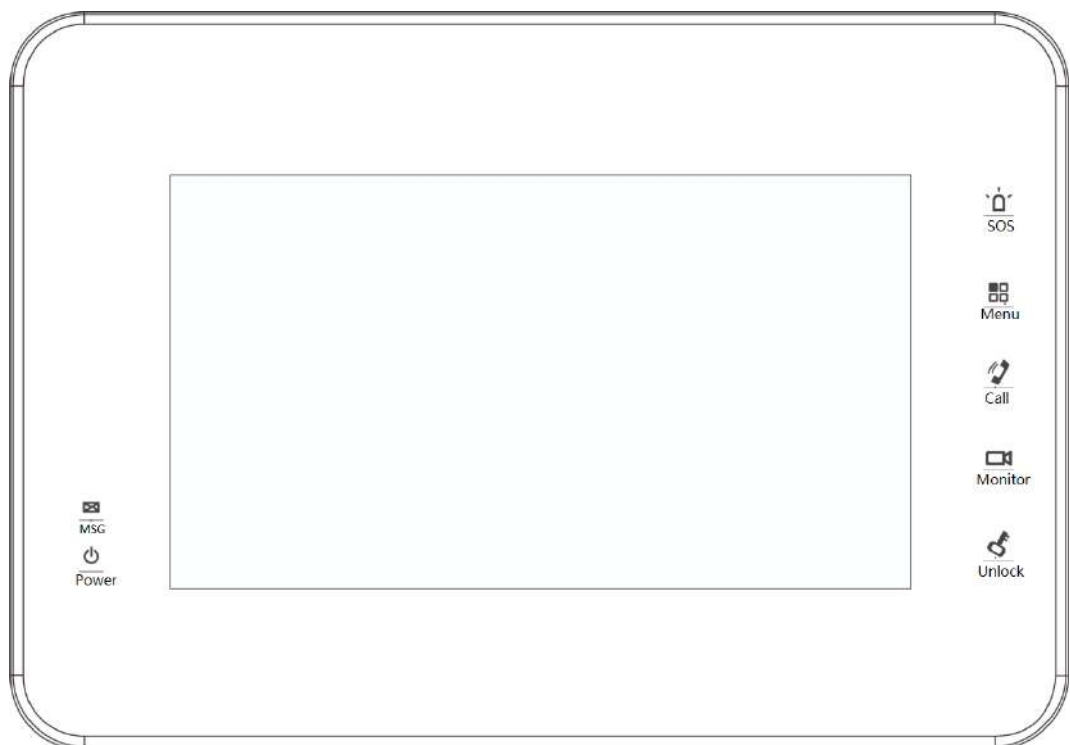

Figure 2-3 VTH15 Series Type B







Icon	Name	Description
 SOS	SOS	Press this key to call the Call Center in case of emergency.
 Menu	Menu	Press this key to return to main menu.
 Call	Call	<ul style="list-style-type: none"> • In case of incoming call, press this key to answer the call. • During talk, press this key to hang up. • During monitoring, press this key to speak to apartment VTO, villa VTO and fence station. • During speaking, press this key to exit speaking.
 Monitor	Monitor	<ul style="list-style-type: none"> • In standby mode, press this key to monitor the main VTO. • During monitoring, press this key to exit monitoring.
 Unlock	Unlock	Press this key during calling, talking, monitoring and speaking of VTO, so corresponding VTO will be unlocked.
 MSG	Message indicator	If this indicator turns on, it represents that there are unread messages.
 Power	Power indicator	If this indicator turns on in green, it represents normal power supply.

Table 2-3

2.1.3 VTH15 Series Type CH/5222H

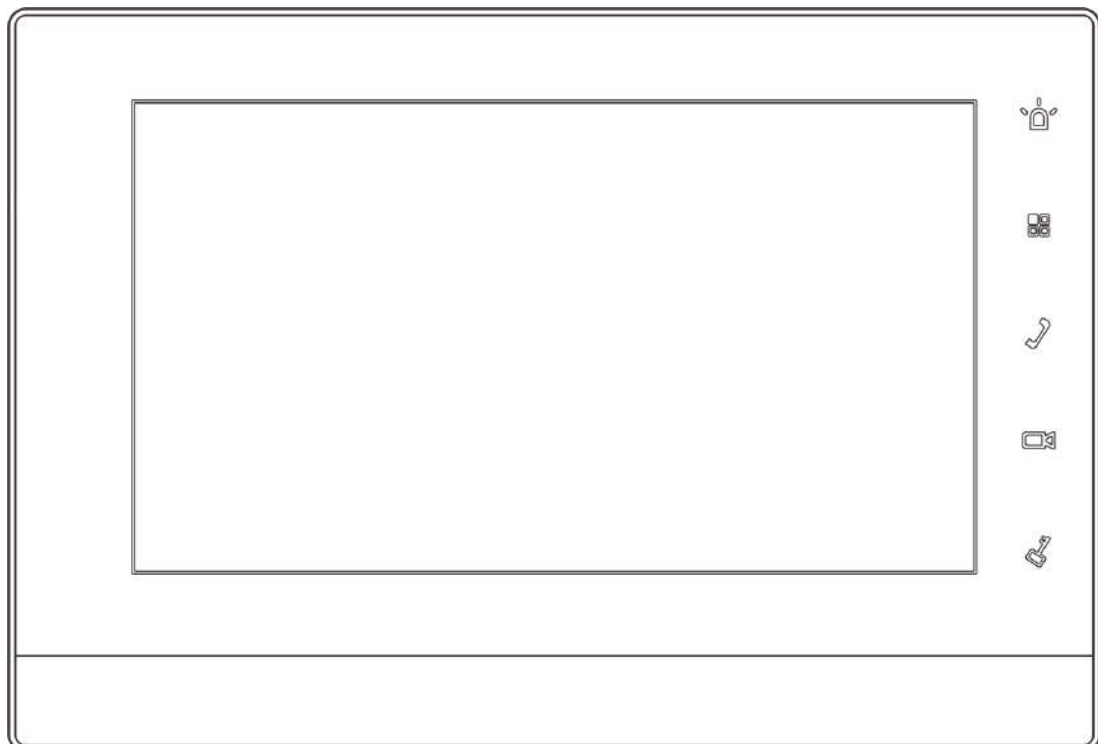

Figure 2-4





Icon	Name	Description
	SOS	Press this key to call the Call Center in case of emergency.
	Menu	Press this key to return to main menu.
	Call	<ul style="list-style-type: none"> • In case of incoming call, press this key to answer the call. • During talk, press this key to hang up. • During monitoring, press this key to speak to apartment VTO, villa VTO and fence station. • During speaking, press this key to exit speaking.
	Monitor	<ul style="list-style-type: none"> • In standby mode, press this key to monitor the main VTO. • During monitoring, press this key to exit monitoring.
	Unlock	Press this key during calling, talking, monitoring and speaking of VTO, so corresponding VTO will be unlocked.

Table 2-4

2.1.4 VTH1660CH

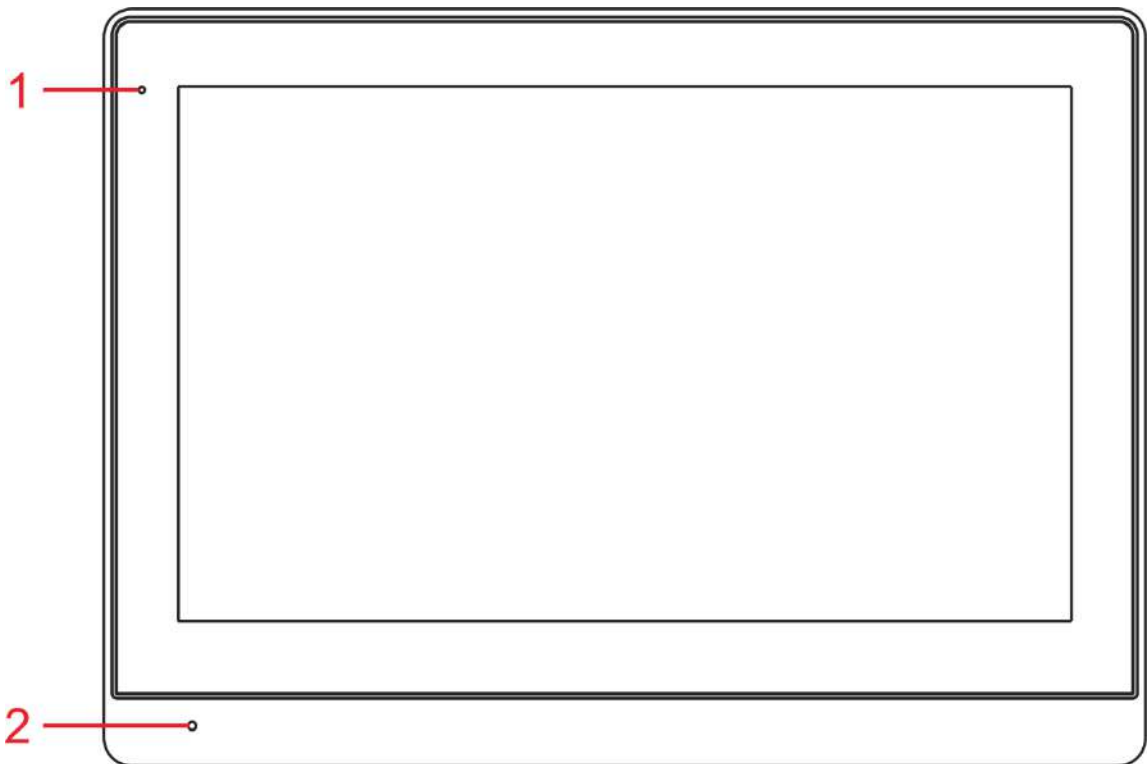

Figure 2-5

No.	Name	Description
1	Power indicator	If this indicator turns on in green, it represents normal power supply.
2	Microphone	Audio input.

Table 2-5

2.1.5 VTH2221A

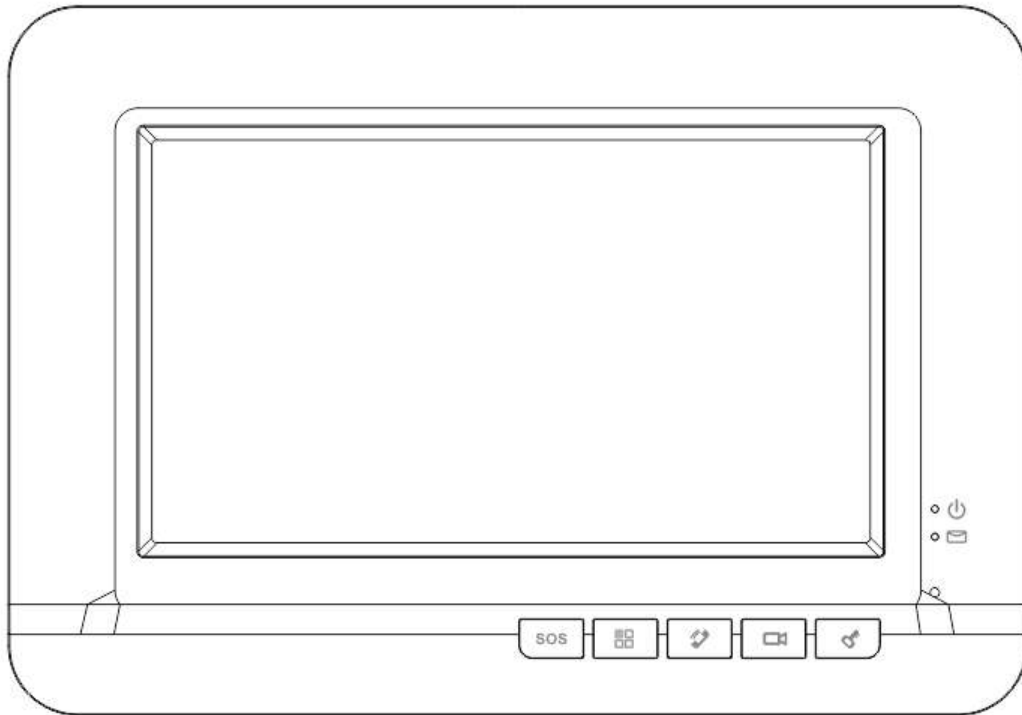

Figure 2-6







Icon	Name	Description
	SOS	Press this key to call the Call Center in case of emergency.
	Menu	Press this key to return to main menu.
	Call	<ul style="list-style-type: none"> • In case of incoming call, press this key to answer the call. • During talk, press this key to hang up. • During monitoring, press this key to speak to apartment VTO, villa VTO and fence station. • During speaking, press this key to exit speaking.
	Monitor	<ul style="list-style-type: none"> • In standby mode, press this key to monitor the main VTO. • During monitoring, press this key to exit monitoring.
	Unlock	Press this key during calling, talking, monitoring and speaking of VTO, so corresponding VTO will be unlocked.
	Power indicator	If this indicator turns on in green, it represents normal power supply.
	Message indicator	If this indicator turns on, it represents that there are unread messages.

Table 2-6

2.2 Rear Panel Port

2.2.1 VTH5221 Series/VTH5241 Series

Port positions are slightly different on the rear panel of VTH5221 series and VTH5241 series, but the same port owns the same function. Taking VTH5221 as an example, specific functions of ports are introduced, as shown in Figure 2-7.

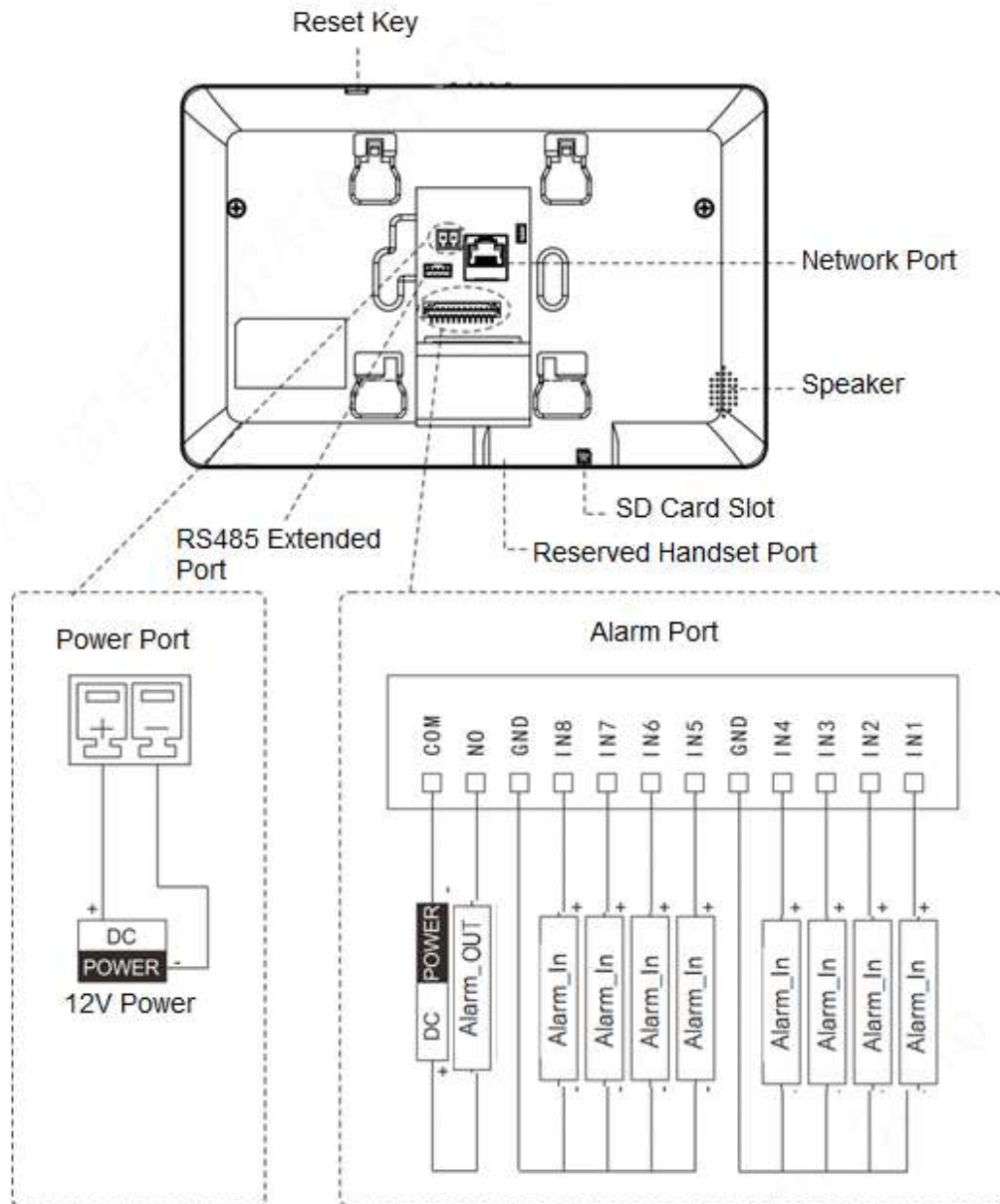

Figure 2-7

2.2.2 VTH15 Series Type A/ Type B/ Type CH

In VTH15 series, different types of digital VTH have different port positions, but the same port owns the same function. Taking VTH1550CH as an example, specific functions of ports are introduced, as shown in Figure 2-8.

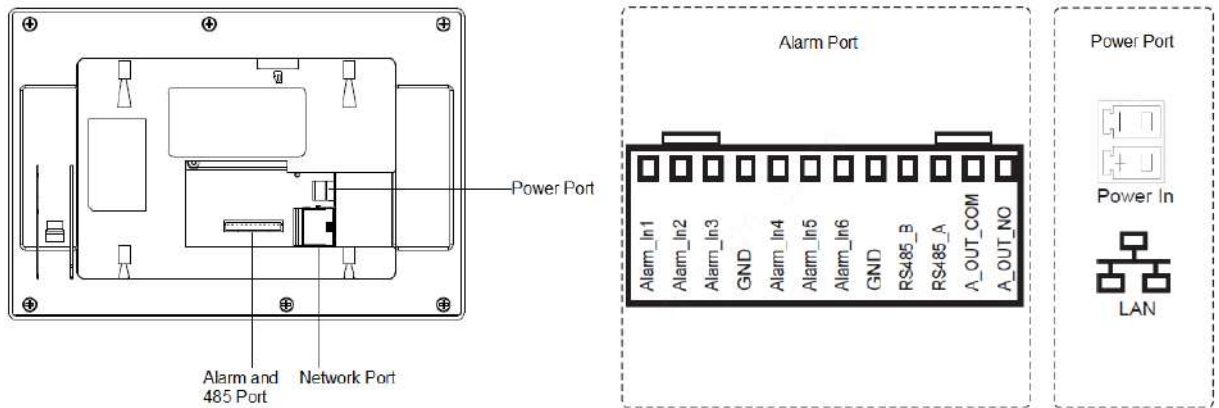

Figure 2-8

In VTH type A/type B series, different types of digital VTH have different port positions, but the same port provides the same function. Taking VTH1560B as an example, specific functions of ports are introduced, as shown in Figure 2-9.

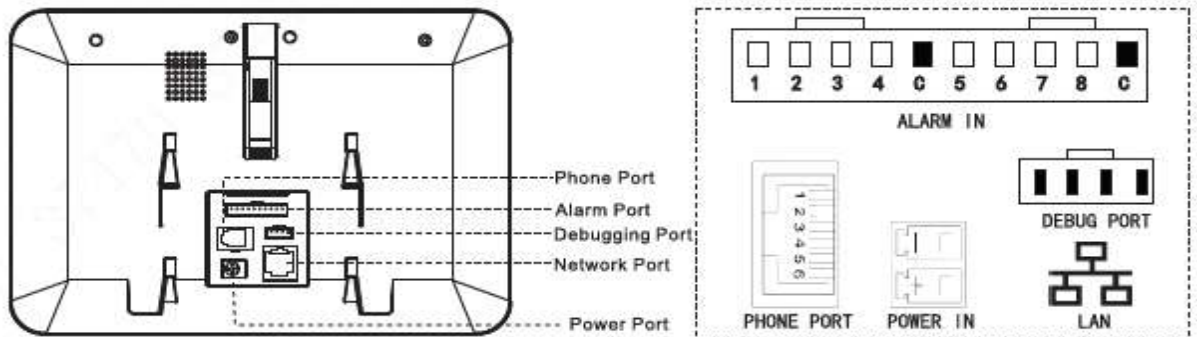

Figure 2-9

2.2.3 VTH5222CH/VTH1550CHW-2

VTH5222CH 2-wire VTH provides 6 alarm input ports, 1 alarm output port, 1 RS485 port and 1 group of 2-wire port, as shown in Figure 2-10. VTH1550CHW-2 has 3 groups of 2-wire port.

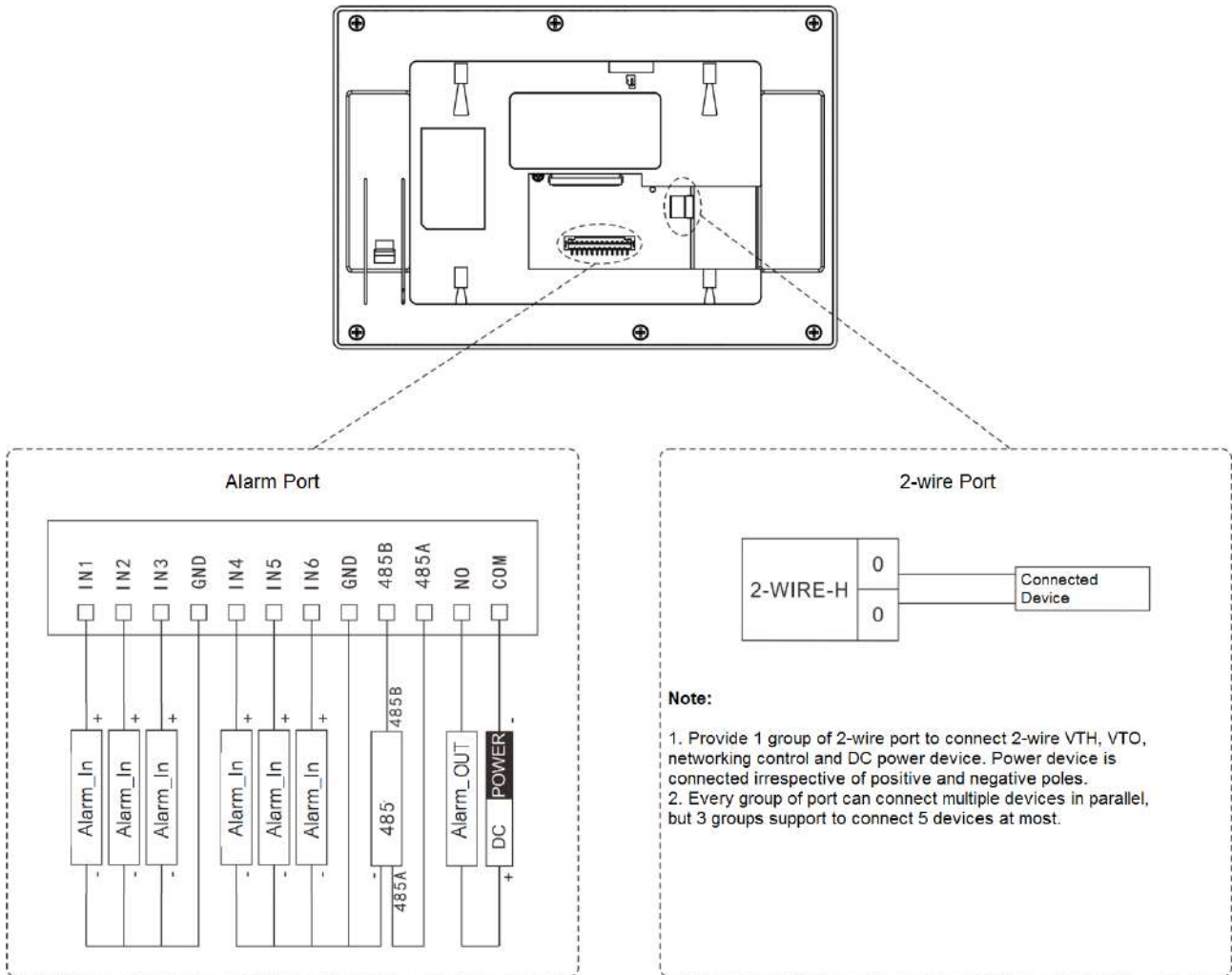

Figure 2-10

2.2.4 VTH1660CH

VTH1660CH digital VTH provides 8 alarm input ports, 1 RS485 port, 1 debugging port, 1 network port and power port, as shown in Figure 2-11.

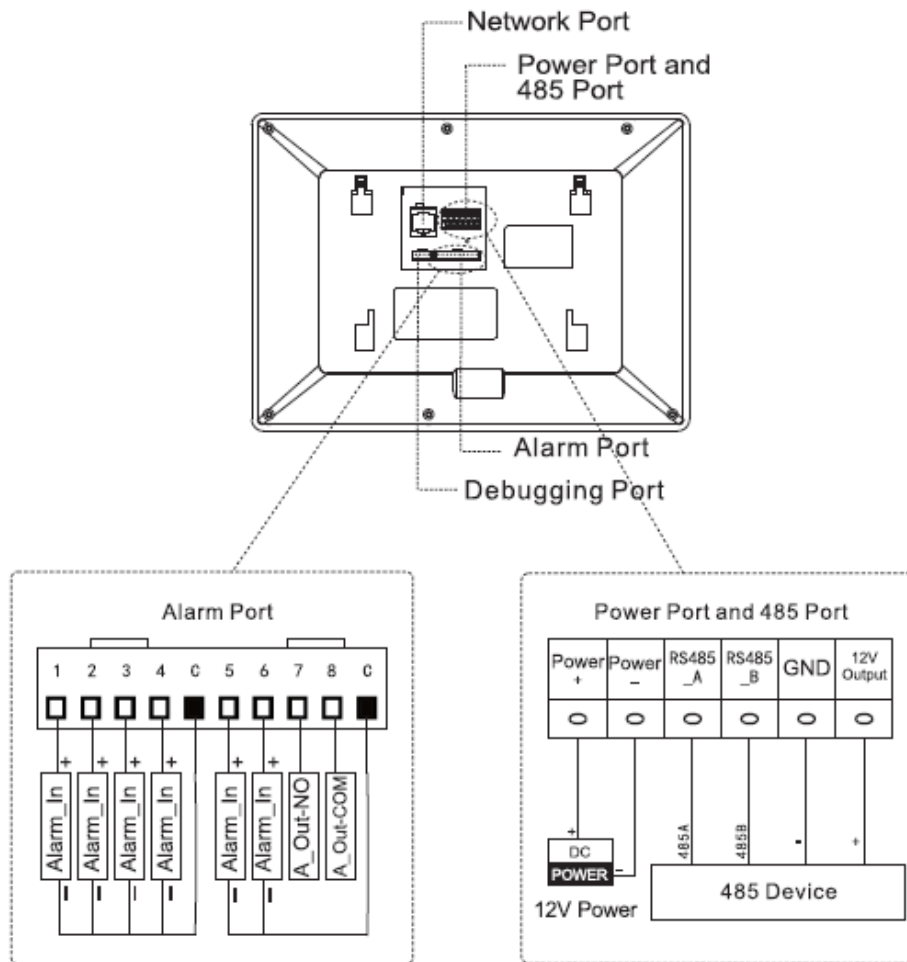

Figure 2-11

2.2.5 VTH2221A

VTH2221A digital VTH provides 8 alarm input ports, 1 network port and power port, as shown in Figure 2-12.

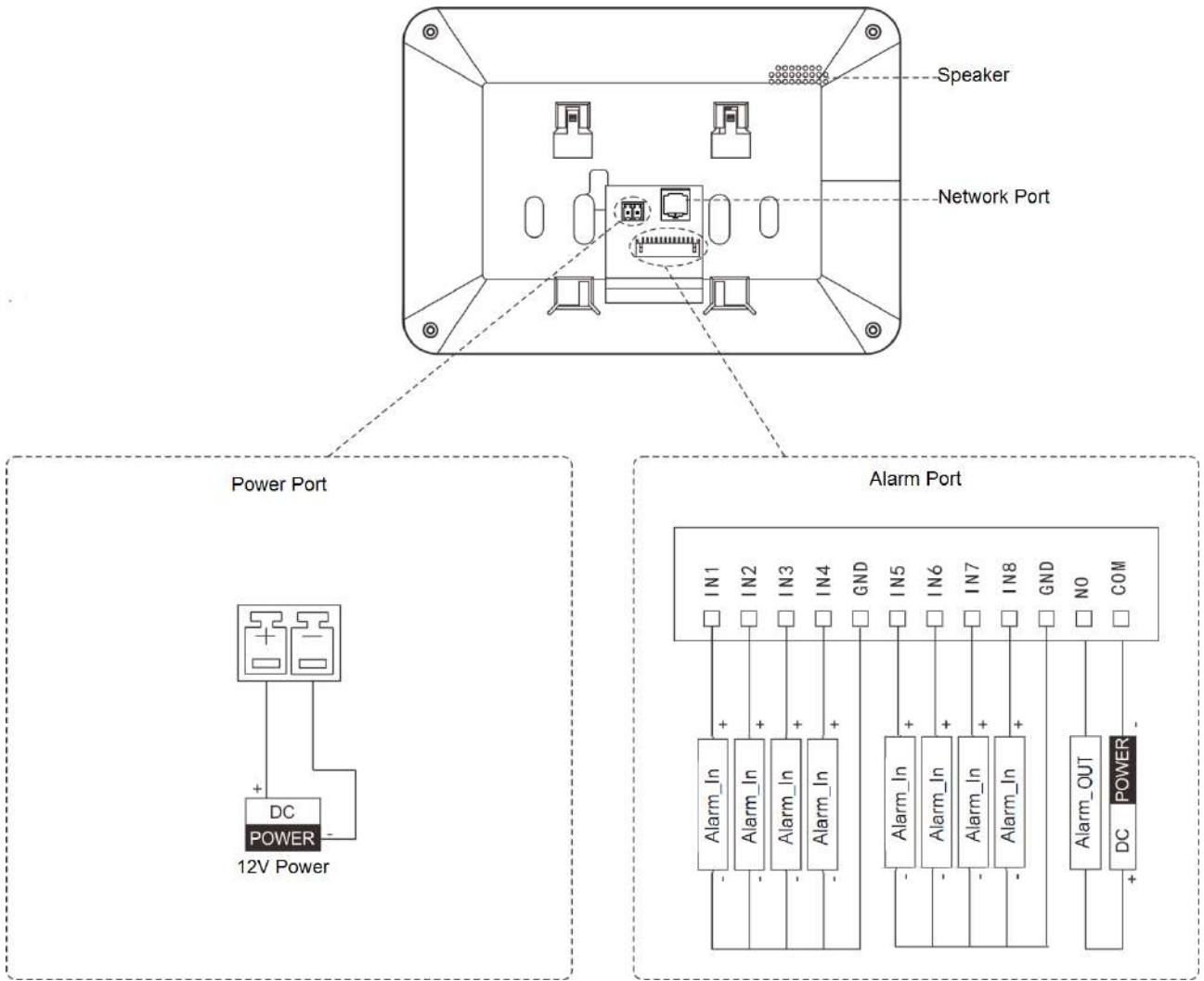

Figure 2-12

3

Network Diagram

3.1 2-wire System

Network diagram of 2-wire system is shown in Figure 3-1.

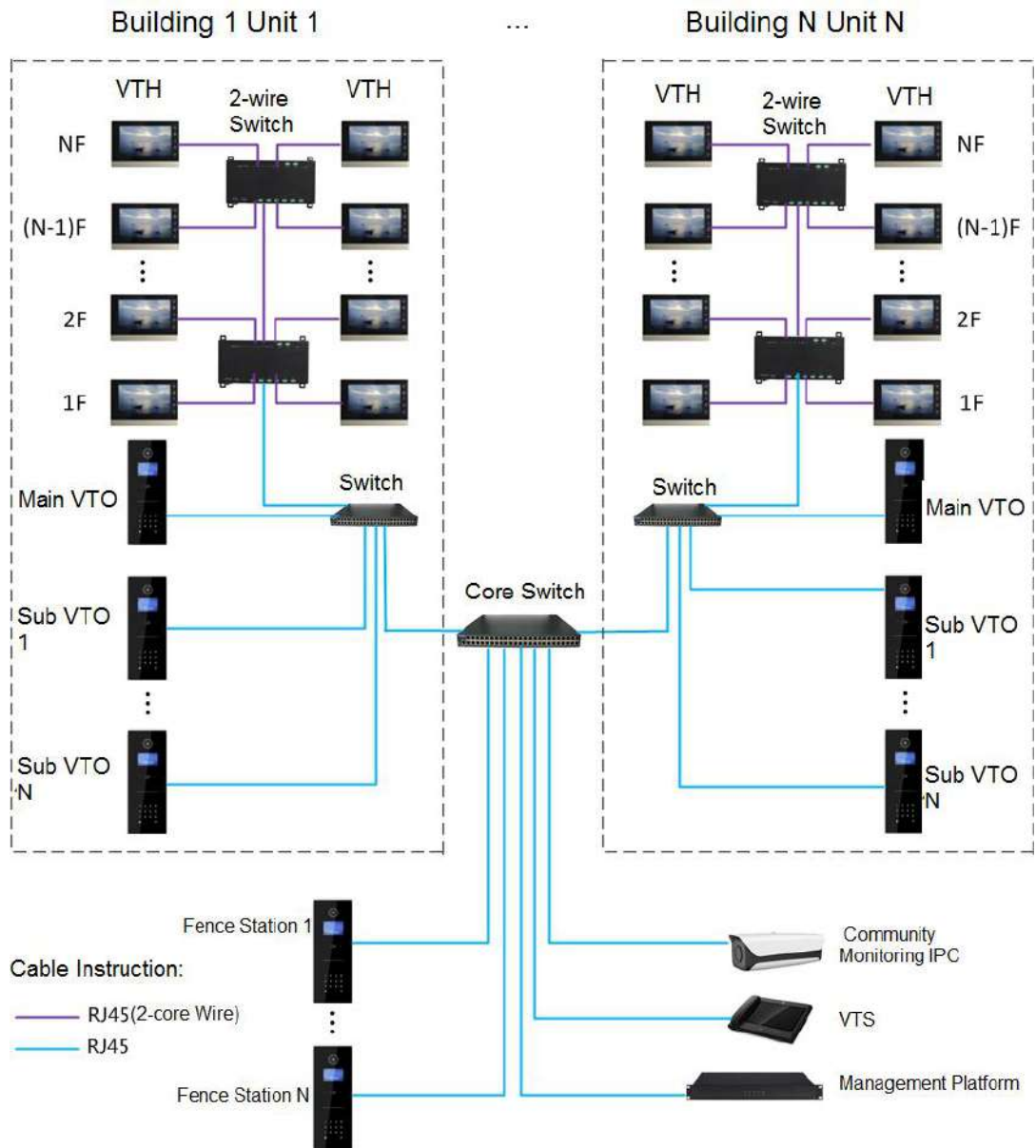

Figure 3-1

3.2 Digital System

Digital system network consist of two types:

- VTH adopts PoE power supply from floor switch, as shown in Figure 3-2.

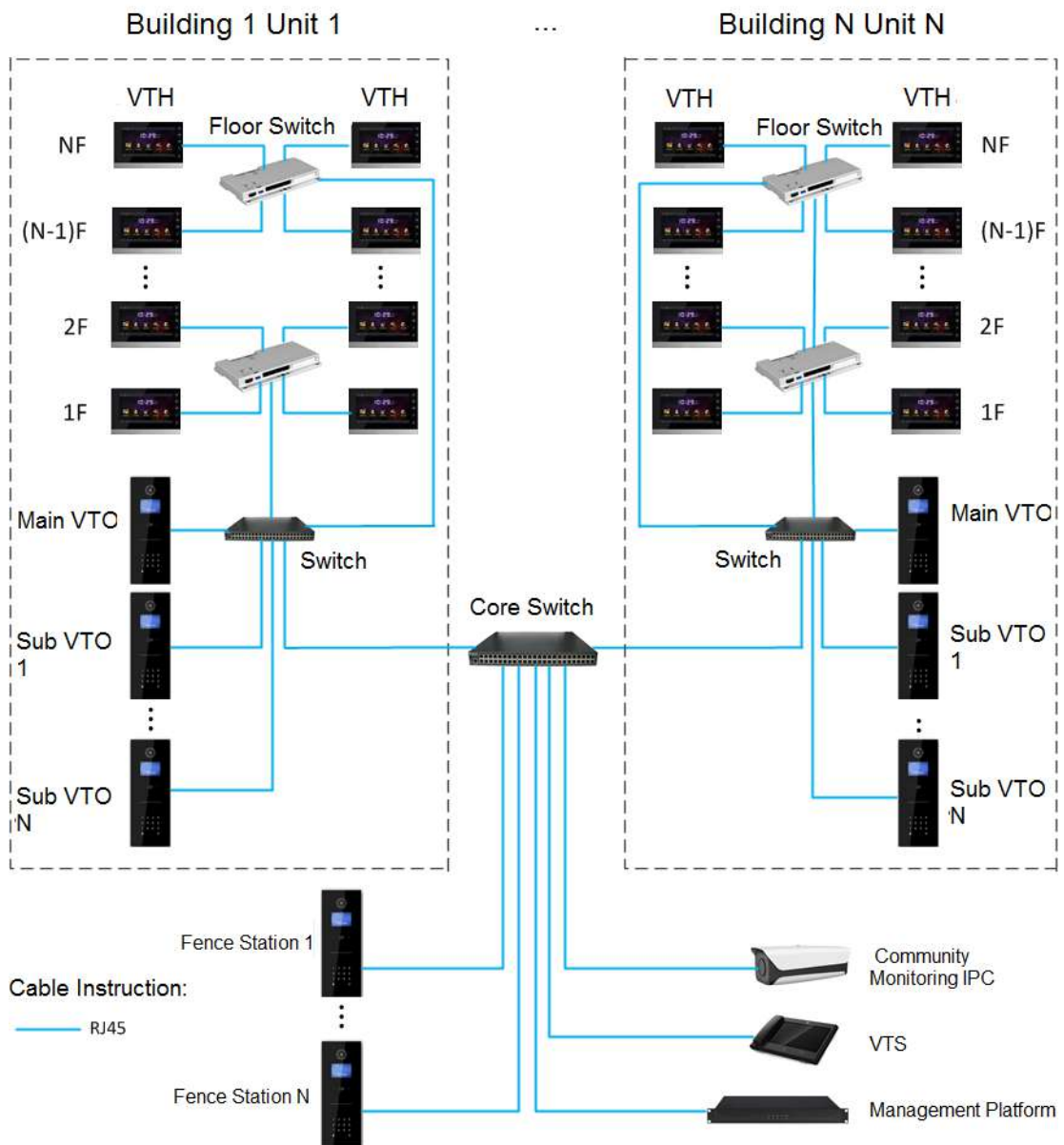

Figure 3-2

- VTH adopts independent power supply from power supply device, as shown in Figure 3-3.

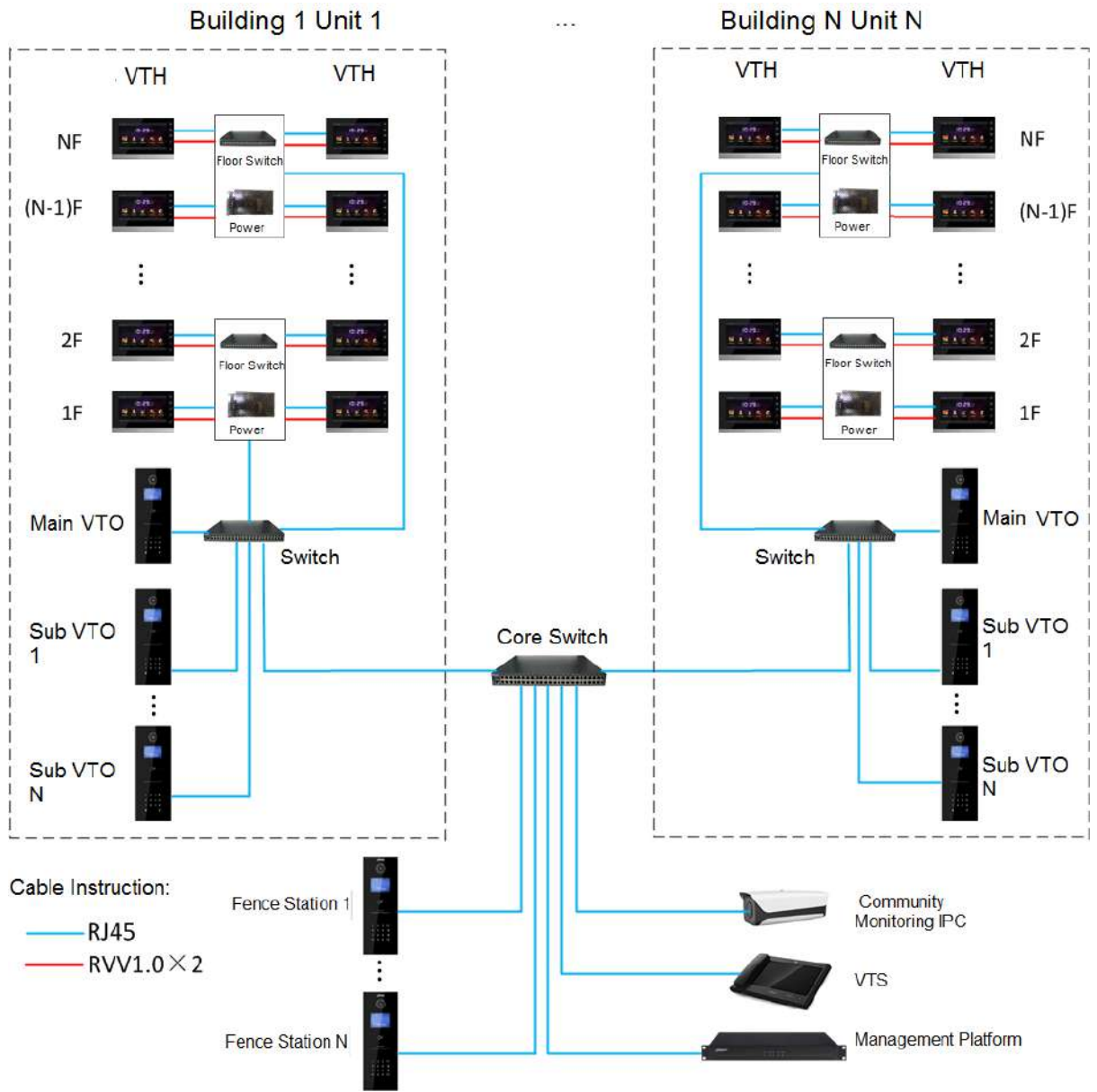

Figure 3-3

4 Device Installation

4.1 Installation Flow Chart

VTH installation flow chart is shown in Figure 4-1 Please install VTH in the following steps.

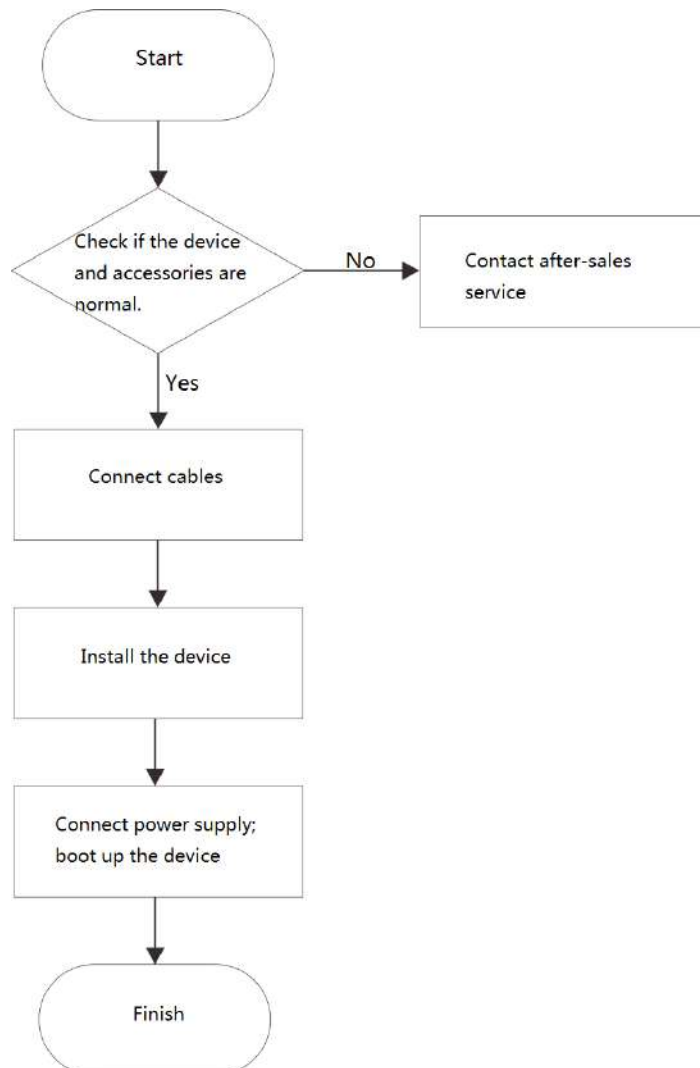

Figure 4-1

 Note

- For cable connection, please refer to “2.2 Rear Panel Port”.
- For device installation, please refer to “4.4 Device Installation”.

4.2 Open-case Inspection

Please carry out open-case inspection when receiving the device. Please timely contact our

after-sales service personnel in case of any problems.

Sequence	Item	Content	
1	Overall package	Appearance	Inspect whether there are obvious damages.
		Package	Inspect whether there are accidental impacts.
		Fittings	Inspect whether fittings are complete.
2	Model and label	Device model	Inspect whether it is consistent with order contract.
		Label on the device	Inspect whether it is torn or damaged.  Note Don't tear or discard the label, otherwise warranty service won't be provided. When dialing our after-sales hotline, please provide serial number of the product.
3	Device	Appearance	Inspect whether there are obvious damages.

Table 4-1

4.3 Installation Requirement

- Don't install VTH in bad environment, such as condensation, high temperature, stained, dusty, chemically corrosive and direct sunshine environment.
- Engineering installation and debugging shall be done by professional teams. Please don't dismantle or repair arbitrarily in case of device failure.

4.4 Device Installation

 Note

It is suggested that installation height of device central point shall be 1.4cm~1.6cm above the ground.

4.4.1 Surface Installation

Directly install the device with a bracket onto a wall, which is suitable for all types of devices. Take "VTH1550CH" for example.

Step 1 Drill holes in the wall according to hole positions of the bracket.

Step 2 Fix installation bracket directly onto the wall with screws.

Step 3 Put the device into installation bracket from top down.

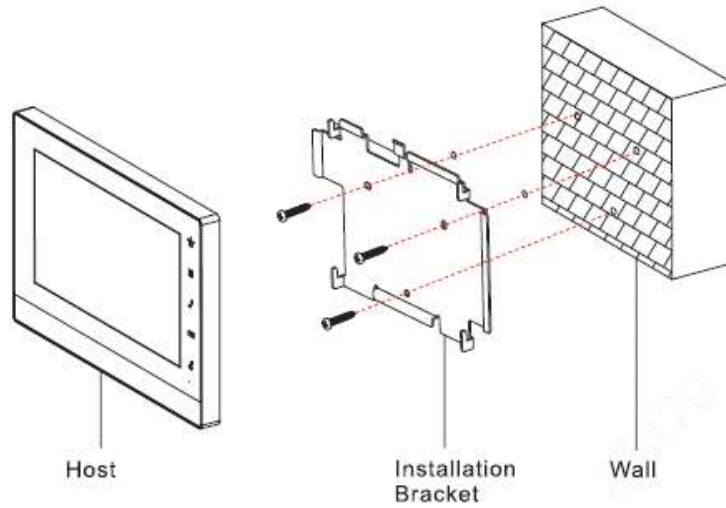

Figure 4-2

4.4.2 Installation with 86 Box

Install the device with 86 box, which is suitable for all types of devices. Take “1560B/BW” for example.

- Step 1 Embed 86 box into a wall at a proper height.
- Step 2 Fix installation bracket onto 86 box with screws.
- Step 3 Put the device into installation bracket from top down.

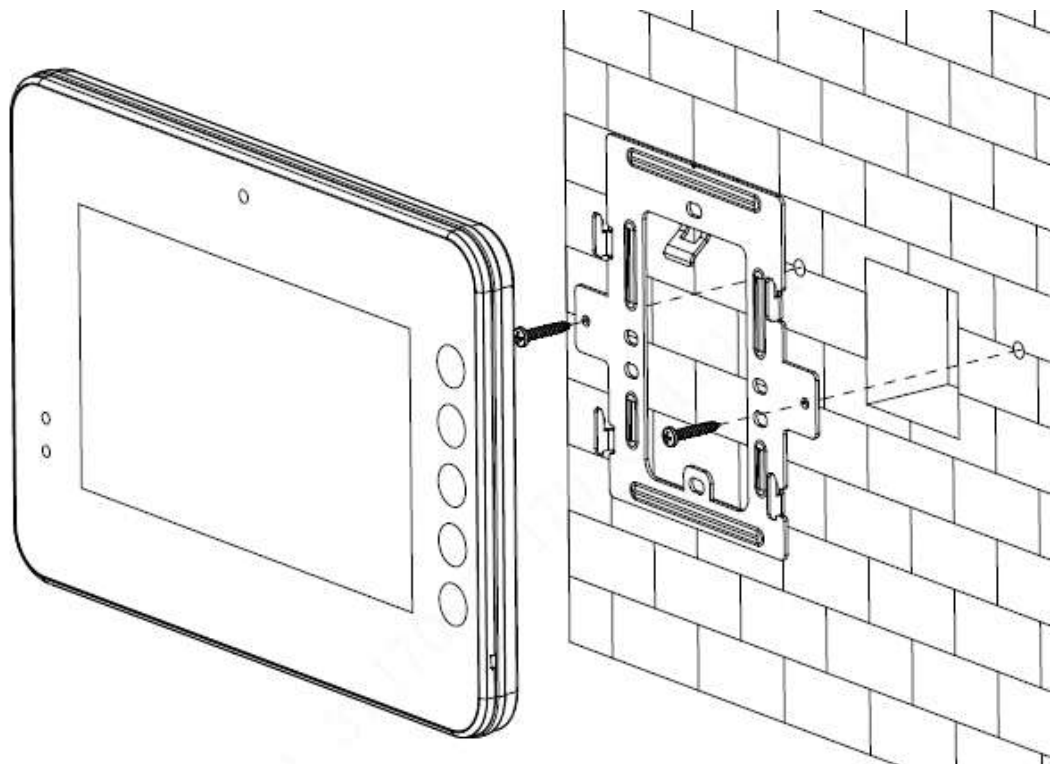

Figure 4-3

Carry out debugging to ensure that the device can realize basic network access, call and monitoring functions after installation. Before debugging, please check whether the following work has been completed.

- Check whether there is short circuit or open circuit. Power on the device only after the circuit is confirmed to be normal.
- IP and no. of every VTO and VTH have been planned.

5.1 Debugging Settings

Set VTO info and VTH info at WEB interface of every VTO, set VTH info, network info and VTO info on every VTH, and thus realize video intercom function.

5.1.1 VTO Settings

5.1.1.1 Initialization

For the first time, please initialize and modify login password.

 Note

Please ensure that default IP addresses of PC and VTO are in the same network segment.

Default IP address of VTO is 192.168.1.110.

Step 1 Connect VTO power and boot up.

Step 2 Enter default IP address of VTO at the address bar of PC browser.

The system displays “Setting” interface, as shown in Figure 5-1.

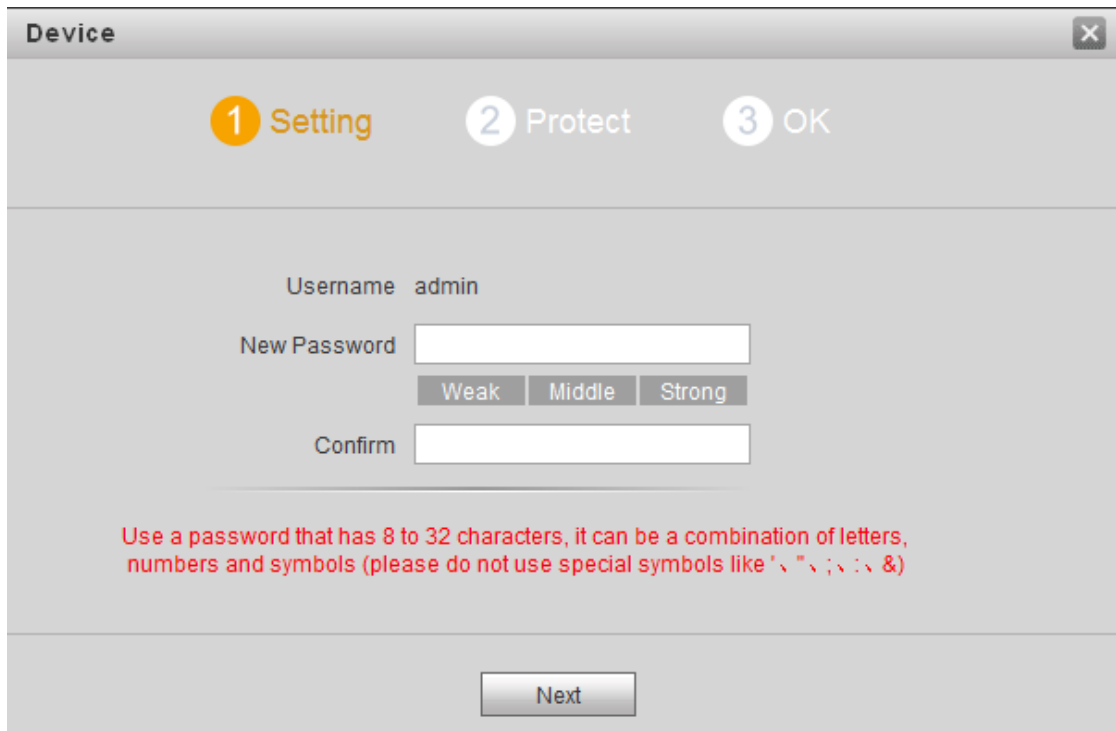

Figure 5-1

Step 3 Enter “New Password” and “Confirm”, and click “Next”.

The system displays “Protect” interface, as shown in Figure 5-2.

 Note

This password is used to login WEB interface. It shall be at least 8 characters, and shall include at least two types of number, letter and symbol.

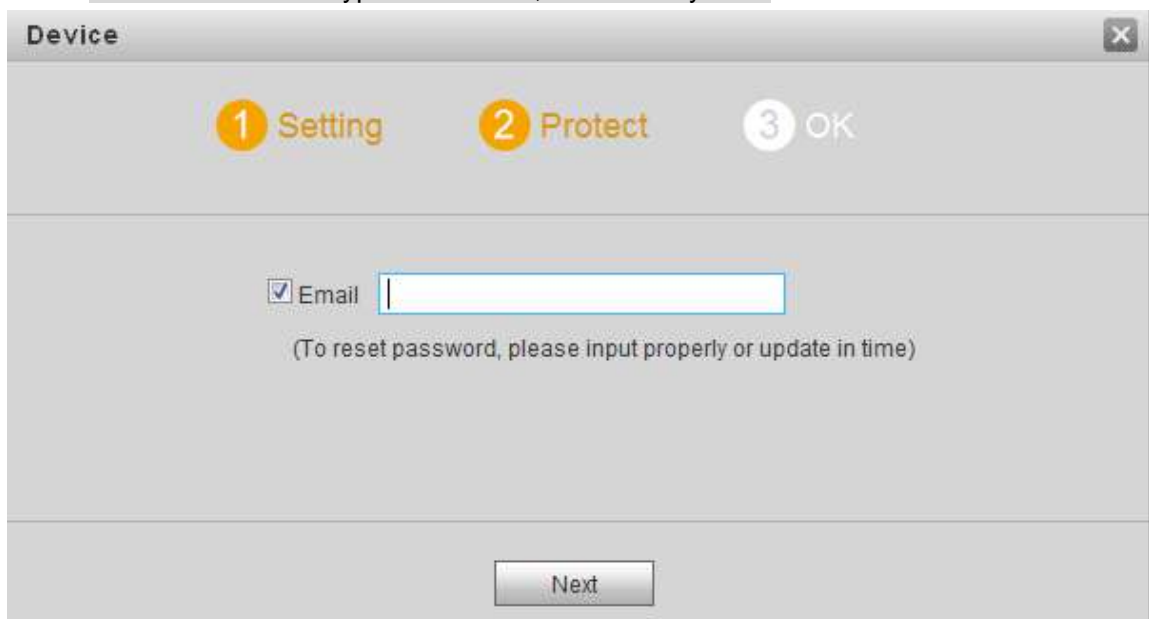

Figure 5-2

Step 4 Select “Email” and enter your Email address.

This Email address is used to reset the password, so it is recommended that it should be set.

Step 5 Click “Next”.

The system displays “OK” interface, as shown in Figure 5-3, and shows “Device succeeded!”

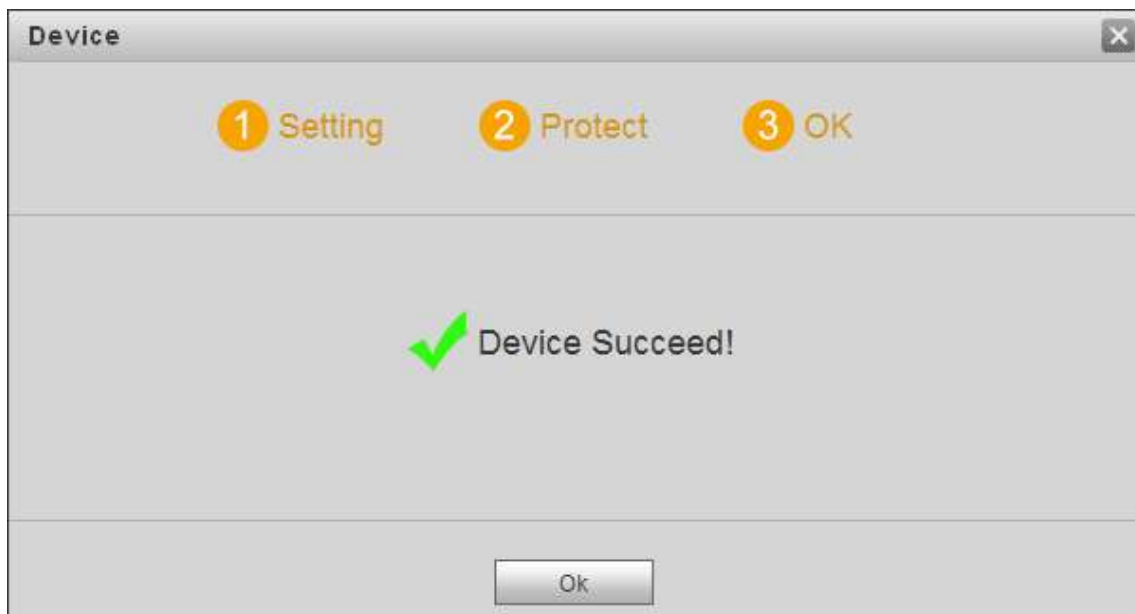

Figure 5-3

Step 6 Click “OK”.

The system displays WEB login interface, as shown in Figure 5-4.

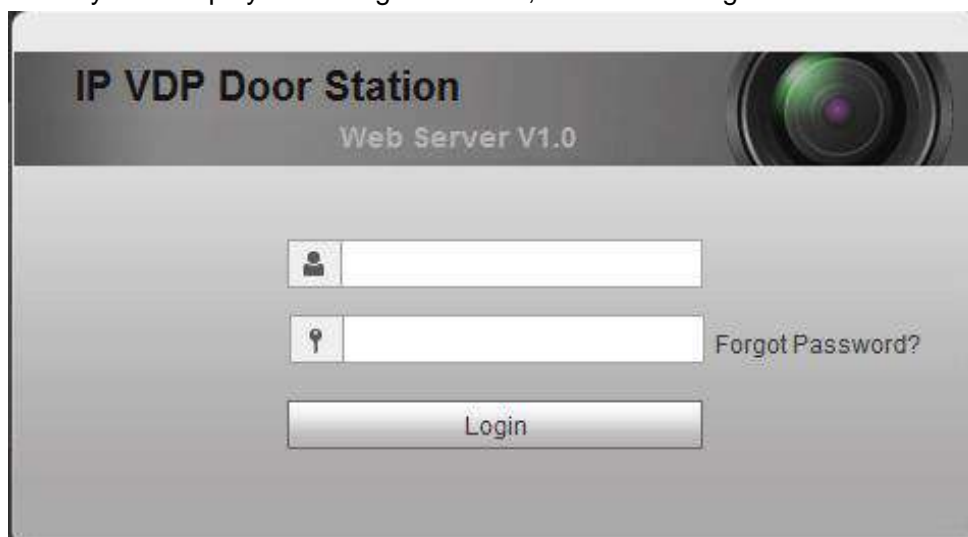

Figure 5-4

Step 7 Enter user name and password, and click “Login”.

Log in the WEB interface of the device.

 Note

- Default user name is admin.
- Password is the one set during initialization.

5.1.1.2 Network Config

Modify IP address of VTO to be planned IP address.

Step 1 Select “System Config > Network Config > TCP/IP”.

The system displays “TCP/IP” interface, as shown in Figure 5-5.

TCP/IP	FTP	Port	DDNS	HTTPS Setting
IP Address	172.26.7.42			
Subnet Mask	255.255.0.0			
Default Gateway	172.26.0.1			
MAC Address	00:01:5b:00:33:55			
DNS Address	8.8.8.8			
SSH	<input type="radio"/> On <input checked="" type="radio"/> Off			
<input type="button" value="Default"/> <input type="button" value="Refresh"/> <input type="button" value="OK"/>				

Figure 5-5

Step 2 Enter the planned “IP Address”, “Subnet Mask” and “Default Gateway”, and click “OK”. After modification is completed, VTO reboots automatically, while the following two cases occur at WEB interface.

- If PC is in the planned network segment, WEB interface jumps to new IP login interface automatically.
- If PC is not in the planned network segment, the webpage cannot be displayed. Please add PC into the planned network segment and login WEB interface again.

5.1.1.3 LAN Config

Set building no., unit no. and VTO no..

Step 1 Select “System Config > LAN Config”.

The system displays “LAN Config” interface, as shown in Figure 5-6.

LAN Config	
Building No.	01
Building Unit No.	1
VTO No.	6901
Max Extension Index	5 <input type="checkbox"/> Group Call
MGT Centre IP Address	10.34.6.102 <input checked="" type="checkbox"/> Register to the MGT Centre
MGT Port No.	12801
NoAnswer Transfer MGT Centre	<input type="radio"/> Enable <input checked="" type="radio"/> Disable
<p style="color: red;">Warning: The device needs reboot after modifying the config above. If extensionCount changed, need reboot VTH and init VTH information again!</p>	
<input type="button" value="Default"/> <input type="button" value="Refresh"/> <input type="button" value="OK"/>	

Figure 5-6

Step 2 Enter VTO “Building No.”, “Building Unit No.” and “VTO No.”.

 Note

- To call management centre, please select “Register to the MGT Centre”; set “MGT Centre IP Address” and “MGT Port No.”.
- To provide group call, please select “Group Call” and set “Max Extension Index”

which can be 5 at most.

Step 3 Click “OK”.

5.1.1.4 Add VTH

Add VTH info. After VTH and VTO debugging is completed, VTH will be registered to VTO automatically, in order to realize binding.

 Note

- Add master VTH only.
- After “Network Terminal” interface of extension VTH adds main VTO and enables it, VTO interface will obtain extension VTH info automatically.

Step 1 Select “System Config > Digital Indoor Station Manager”.

The system displays “Digital Indoor Station Manager” interface, as shown in Figure 5-7.

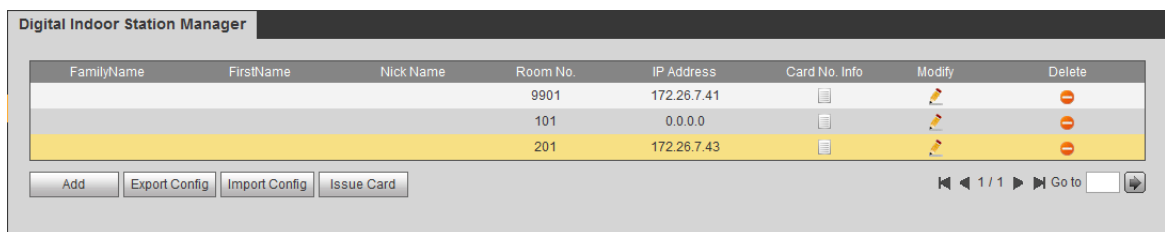
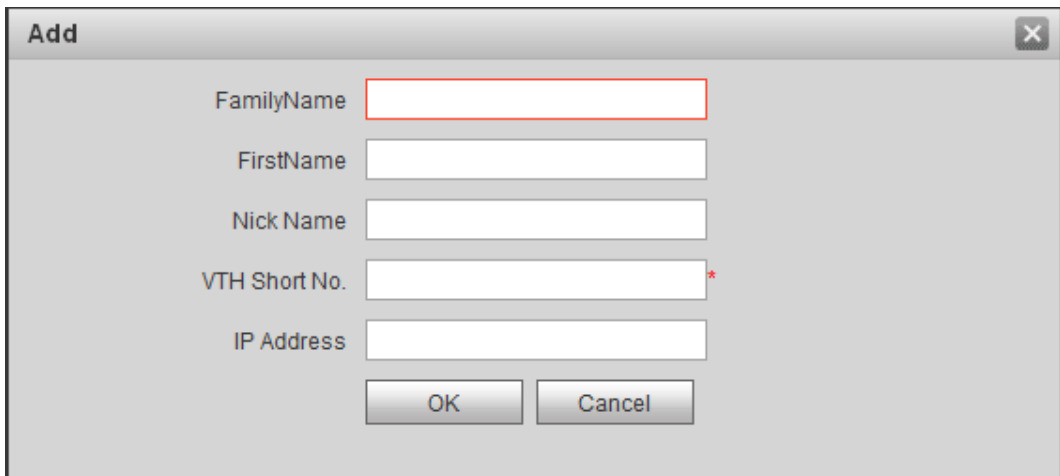

Figure 5-7

Step 2 Click “Add”.

The system displays “Add” interface, as shown in Figure 5-8.



The screenshot shows the 'Add' dialog box. It has a title bar with 'Add' and a close button. The dialog contains five input fields: 'FamilyName', 'FirstName', 'Nick Name', 'VTH Short No.', and 'IP Address'. The 'VTH Short No.' field has a red asterisk next to it, indicating it is a required field. At the bottom of the dialog are 'OK' and 'Cancel' buttons.

Figure 5-8

Step 3 Enter VTH “Family Name”, “First Name”, “Nick Name”, “VTH Short No.” (VTH room no.) and “IP Address”.

 Note

It is OK if IP address is not filled in. After VTH is registered to VTO successfully, VTO will obtain IP address of VTH.

Step 4 Click “OK”.

5.1.2 VTH Config

5.1.2.1 Initialization

Set the password and bind your Email.

- Password: it is used to enter project setting interface.
- Email: it is used to retrieve your password when you forget it.

Step 1 Power on the device.

The system displays “Welcome” and enters “Device Initialization” interface, as shown in Figure 5-9.



Figure 5-9

Step 2 Enter “Password”, “Confirm Pwd” and “Email”. Click [OK].

The system displays main interface.

5.1.2.2 Network Config

According to available network connection modes, configure VTH network information.

 Note

IP addresses of VTH and VTO shall be in the same network segment. Otherwise, VTH will fail to obtain VTO info after configuration.

Step 1 Press [Setting] for more than 6 seconds.

The system pops up “Password” prompt box.

Step 2 Enter the password set during initialization, and click [OK].

Step 3 Click [Network].

The system displays “Network” interface, as shown in Figure 5-10 and Figure 5-11.

 Note

Only devices with the wireless function can access to wireless network.

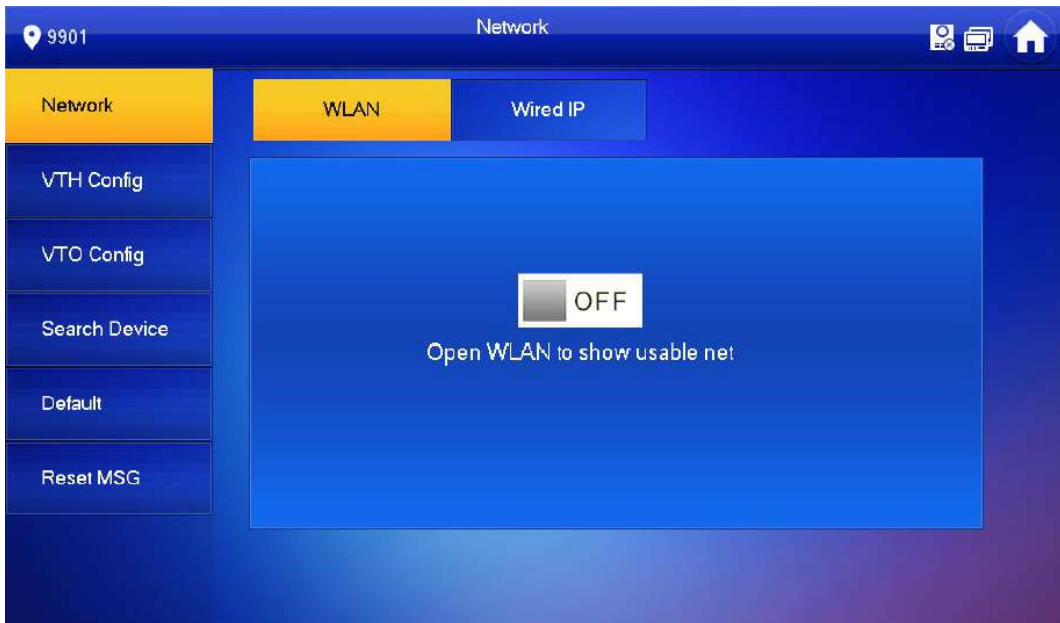

Figure 5-10

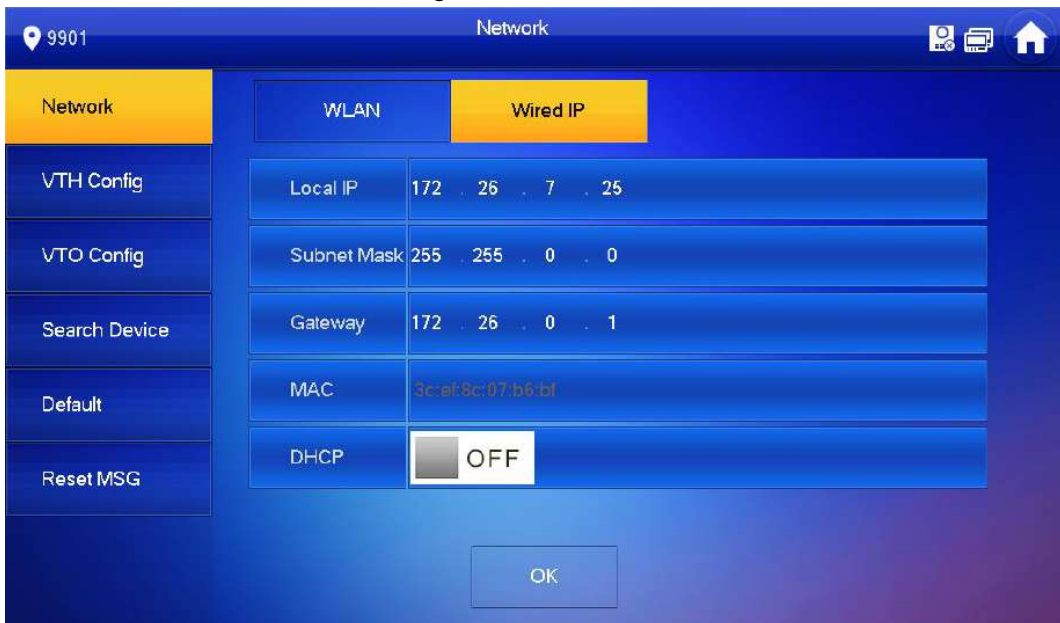

Figure 5-11

Step 4 Set according to actual network access mode.

- Wired IP

Enter “Local IP”, “Subnet Mask” and “Gateway”, press [OK]. Or press OFF to enable DHCP function and obtain IP info automatically.

 Note

If the device has wireless function, please click “Wired IP” tab to set it.

- WLAN

1. Press OFF to enable WIFI function.

The system displays available WIFI list, as shown in Figure 5-12.



Figure 5-12

2. Connect WIFI.

The system has 2 access ways as follows.

- ◇ At “WLAN” interface, select WIFI, click “Wireless IP” tab to enter “Local IP”, “Subnet Mask” and “Gateway”, and press [OK].
- ◇ At “WLAN” interface, select WIFI, click “Wireless IP” tab, press OFF to enable DHCP function and obtain IP info automatically, as shown in Figure 5-13.

 Note

To obtain IP info with DHCP function, use a router with DHCP function.

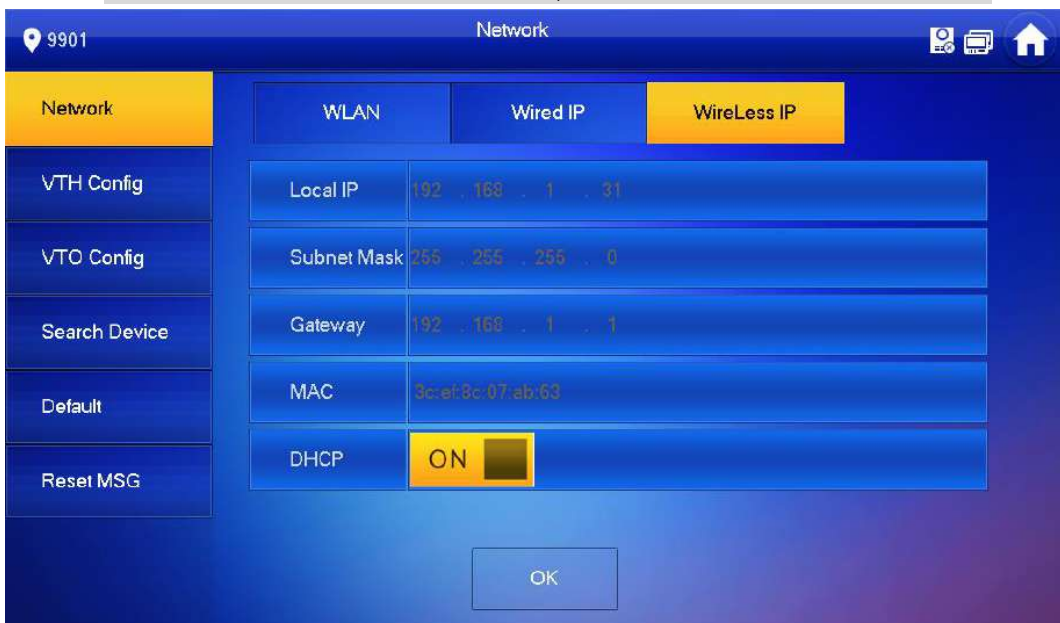

Figure 5-13

5.1.2.3 VTH Config

Set VTH “Room No.”, type and “Master IP”.

Step 1 Press [Setting] for more than 6 seconds.

The system pops up “Password” prompt box.

Step 2 Enter the password set during initialization, and click [OK].

Step 3 Click [VTH Config].

The system displays “VTH Config” interface, as shown in Figure 5-14.



Figure 5-14

Step 4 Set VTH info.

- Be used as a master VTH.
Enter “Room No.” (such as 9901).

 Note

“Room no.” shall be the same with “VTH Short No.”, which is set when adding VTH at WEB interface. Otherwise, it will fail to connect VTO.

- Be used as an extension VTH.
 1. Press [Master] and switch to “Extension”.
 2. Enter “Room No.” (such as 9901-1) and “Master IP” (IP address of master VTH).

 Note

“Master Name” and “Master Pwd” are the user name and password of master VTH. Default user name is admin, and the password is the one set during device initialization.

Step 5 Press [OK] to save settings.

5.1.2.4 VTO Config

Add VTO and fence station info; at VTH interface, bind VTH with VTO.

Step 1 Press [Setting] for more than 6 seconds.

The system pops up “Password” prompt box.

Step 2 Enter the password set during initialization, and click [OK].

Step 3 Click [VTO Config].

The system displays “VTO Config” interface, as shown in Figure 5-15.



Figure 5-15

Step 4 Add VTO or fence station.

- Add main VTO.
 1. In Figure 5-15, enter main VTO name, VTO IP, “User Name” and “Password”.
 2. Switch the “Enable Status” to be ON .

 Note

- “User Name” and “Password” shall be consistent with WEB login user name and password of VTO. Otherwise, it will fail to connect.
- “Enable Status” of main VTO is “ON” by default. After setting VTO info, it will take effect after turning it off and then turning it on again.
- Add sub VTO.
 1. Press > to switch to sub VTO setting interface.
 2. Enter sub VTO name, IP address, “User Name” and “Password”.
 3. Switch the “Enable Status” to be ON .
- Add fence station.
 1. Press > to switch to sub VTO setting interface.
 2. Select device type to be “Fence Station”, enter Sub VTO name (fence station name), middle no. (fence station no.), “User Name” and “Password”.
 3. Switch the “Enable Status” to be ON .

5.2 Debugging Verification

5.2.1 VTO Calls VTH

Dial VTH room no. (such as 9901) at VTO, and thus call VTH. VTH pops up monitoring image and operating keys, as shown in Figure 5-16. It represents successful debugging.

 Note

The following figure means that SD card has been inserted into VTH. If SD card is not inserted, recording and snapshot icons are gray.



Figure 5-16

5.2.2 VTH Monitors VTO

VTH is able to monitor VTO, fence station or IPC. Take “VTO” for example.

Select “Monitor > Door”, as shown in Figure 5-17. Select the VTO to enter monitoring image, as shown in Figure 5-18.

 Note

The following figure means that SD card has been inserted into VTH. If SD card is not inserted, recording and snapshot icons are gray.



Figure 5-17

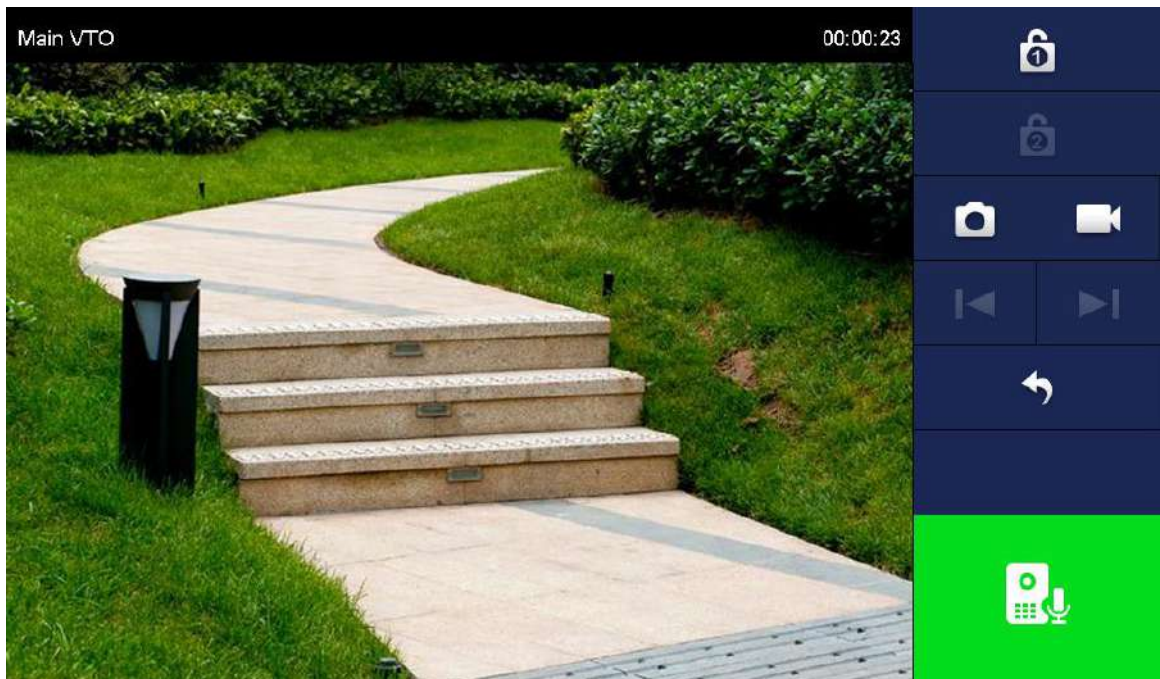

Figure 5-18

6

Interface Operation

6.1 Main Interface

There are six items at the main interface, namely, call, info, monitor, SOS, setting and arm/disarm, as shown in Figure 6-1. For description of every item, please refer to Table 6-1.

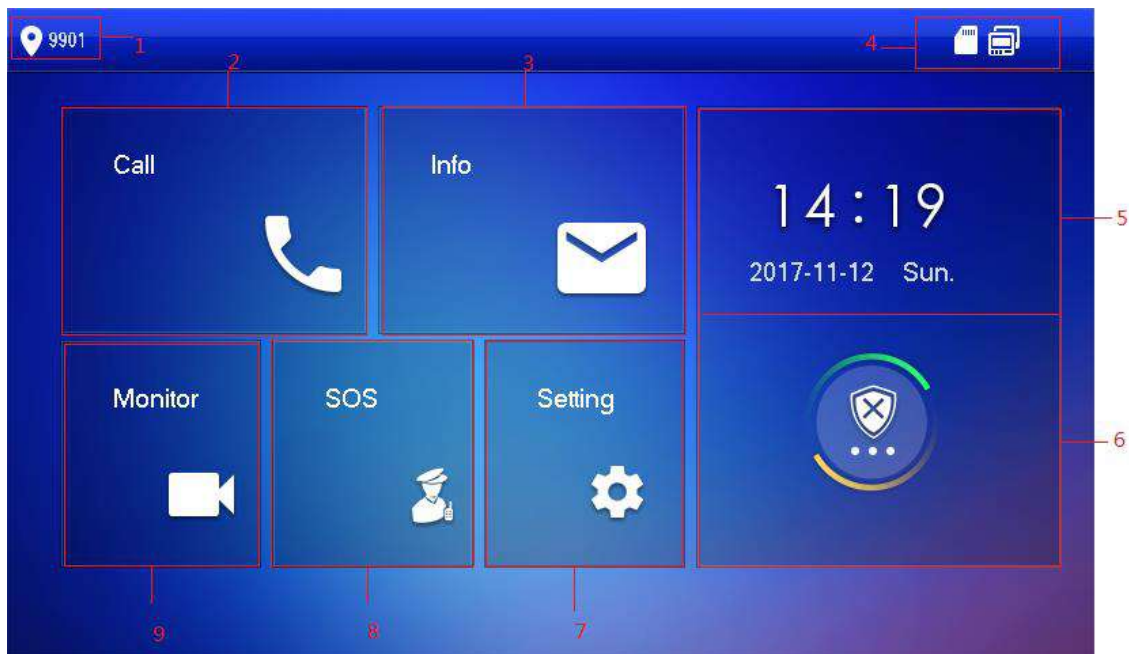

Figure 6-1

No.	Name	Description
1	Room No.	Number of the room where VTH is located.
2	Call	<ul style="list-style-type: none">• Call a user.• Manage the contacts.• View and manage the call records.
3	Info	<ul style="list-style-type: none">• View, delete and clear notices issued by Property Management Center.• View, delete and clear security alarm info.• When VTH owns a SD card or VTO enables video-audio message uploading function, “Guest Message” tab will be displayed. View, delete and clear messages of VTO.• When VTH owns a SD card, “Video Pic” tab will be displayed. View, delete and clear videos and pictures.







No.	Name	Description
4	Status Bar	<ul style="list-style-type: none"> • : Wired network connection icon, meaning that the device isn't connected with network. • : Wired network connection icon, meaning that the device has connected with network in a wired way. • : Wi-Fi network connection icon, meaning that the device has connected with network in a wireless way. • : Main VTO connection icon, meaning that the device failed to connect main VTO; without this icon, the device has connected with main VTO successfully. • : SD card icon, meaning that SD card has been inserted into the device; without this icon, the SD card has not been inserted or the device doesn't support SD card. • : DND (Do Not Disturb) icon, meaning that the device has enabled DND function. It is not enabled by default.
5	Time	Display date, day of the week and time.
6	Arm/disarm	<ul style="list-style-type: none"> • Display the last unread alarm info. • : press this icon to enter arm mode selection.
7	Setting	<ul style="list-style-type: none"> • Press [Setting], input login password and enter system setting interface. • Press [Setting] for over 6 seconds, input the password set during initialization, and enter project setting interface.
8	SOS	Press this icon to call Management Center.
9	Monitor	Monitor the VTO, fence station, IPC, NVT, HCVR and XVR.

Table 6-1

6.2 Setting

6.2.1 Ring Settings

Set VTO ring, VTH ring, alarm ring and other rings.

6.2.1.1 VTO Ring

Set a ring for the device connected with VTO, and support to set maximum 20 VTOs.

Step 1 Press [Setting].

The system pops up “Password” prompt box.

Step 2 Input login password and press [OK].

 Note

Default login password is 123456. Please refer to “6.2.5.3 Password Setting” for details.

Step 3 Select “Ring > VTO Ring”.

The system displays “VTO Ring” interface, as shown in Figure 6-2. Press  or



 to page up and down.



Figure 6-2

Step 4 Press text box to select rings, and press  and  to set the volume.

6.2.1.2 VTH Ring

Set the ring of this VTH.

Step 1 Press [Setting].

The system pops up “Password” prompt box.

Step 2 Input login password and press [OK].

 Note



Default login password is 123456. Please refer to “6.2.5.3 Password Setting” for details.

Step 3 Select “Ring > VTH Ring”.

The system displays “VTH Ring” interface, as shown in Figure 6-3.



Figure 6-3

Step 4 Press text box to select rings, and press  and  to set the volume.

6.2.1.3 Alarm Ring

Set the ring when VTH gives an alarm.

Step 1 Press [Setting].

The system pops up “Password” prompt box.

Step 2 Input login password and press [OK].

 Note



Default login password is 123456. Please refer to “6.2.5.3 Password Setting” for details.

Step 3 Select “Ring > Alarm Ring”.

The system displays “Alarm Ring” interface, as shown in Figure 6-4.



Figure 6-4

Step 4 Press text box to select rings, and press  and  to set the volume.

6.2.1.4 Other

Set VTO ring time, VTH ring time, MIC volume, talk volume and ring mute setting.

Step 1 Press [Setting].

The system pops up “Password” prompt box.

Step 2 Input login password and press [OK].

 Note





Default login password is 123456. Please refer to “6.2.5.3 Password Setting” for details.

Step 3 Select “Ring > Other”.

The system displays “Other” interface, as shown in Figure 6-5.



Figure 6-5

Step 4 Press  and  to set the time or volume. Press  OFF to enable “Ring Mute”, and the icon becomes .

 Note

- “VTO Ring Time” and “VTH Ring Time” of the extension VTH are synchronized with master VTH, and cannot be set.
- VTO ring time: ring time when VTO calls VTH.
- VTH ring time: ring time when another VTH calls this VTH.

6.2.2 DND Settings

Set to avoid incoming calls within a time period.



Caution

- DND function is not enabled by default.
- Under DND mode, there is no call reminder when VTH is called, but call info is recorded.
- Parameters at this interface are set on master VTH only, and extension VTH synchronize with master VTH.

Step 1 Press [Setting].

The system pops up “Password” prompt box.

Step 2 Input login password and press [OK].

 Note

Default login password is 123456. Please refer to “6.2.5.3 Password Setting” for details.

Step 3 Press [DND].

The system displays “DND Settings” interface, as shown in Figure 6-6.



Figure 6-6

Step 4 Press OFF to enable DND function, and the icon becomes ON.

The system displays DND period, as shown in Figure 6-7.

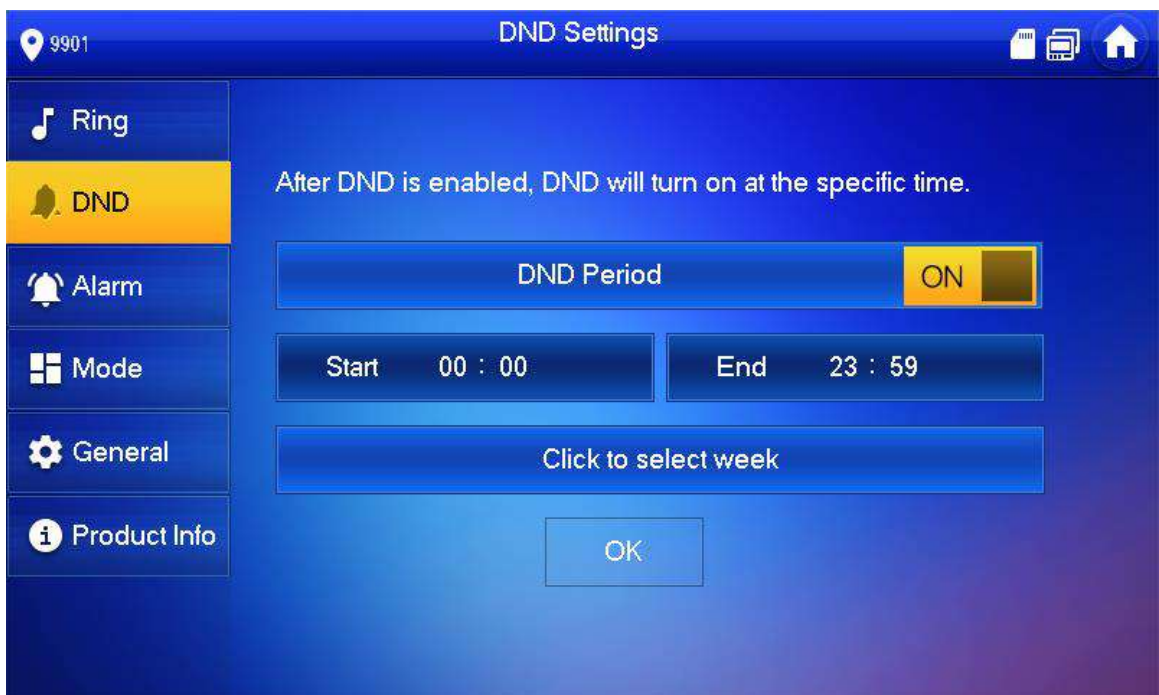

Figure 6-7

Step 5 Press time text box; set start time and end time.

Step 6 Press [Click to select week] and select DND week.

Step 7 Press [OK] to save settings.

6.2.3 Alarm Setting

Set wire zone, wireless zone and alarm output.



Caution

Zones can be set under disarm mode.

6.2.3.1 Wire Zone

Set zone type, NO/NC, alarm status and delay. It supports to set 8 zones at most.

Step 1 Press [Setting].

The system pops up “Password” prompt box.

Step 2 Input login password and press [OK].

Note

Default login password is 123456. Please refer to “6.2.5.3 Password Setting” for details.

Step 3 Select “Alarm > Wire Zone”.

The system displays “Wire Zone” interface, as shown in Figure 6-8.



Figure 6-8

Step 4 Press corresponding positions to set zone type, NO/NC, alarm status, enter delay and exit delay. Please refer to Table 6-2 for details.

Parameter	Description
Area No.	The number cannot be modified.
NO/NC	Select NO (normally open) or NC (normally closed) according to detector type. It shall be the same as detector type.
Type	Select corresponding type according to detector type, including IR, gas, smoke, urgency btn, door, burglar alarm, perimeter and doorbell.



Parameter	Description
Status	<p>It includes instant alarm, delay alarm, bypass and remove.</p> <ul style="list-style-type: none"> Instant alarm: in case of alarm after arm, produce alarm sound at once and enters alarm status. Delay alarm: in case of alarm after arm, enter alarm status after some time. Within the time period, you can disarm and cancel the alarm. Bypass: this area is shielded from this arm. After disarm, this area will restore normal working status. Remove: this area is invalid during arm/disarm. <p> Note An zone under “Remove” status cannot be bypassed.</p>
Enter Delay	<p>After entering delay, when armed area triggers an alarm, entering armed area from non-armed area within the delay time period will not lead to linkage alarm. Linkage alarm will be produced if delay time comes to an end and it is not disarmed.</p> <p> Note Delay is only valid to the areas of “delay alarm”.</p>
Exit Delay	<p>After arm, “delay alarm” area will enter arm status at the end of “exit delay”.</p> <p> Note If multiple areas set the exit delay, interface prompt will conform to maximum delay time.</p>

Table 6-2

Step 5 Press [OK] to complete setting.

6.2.3.2 Wireless Zone



Caution

Only devices with wireless function have this function.

Add, delete and set wireless zones.

Step 1 Press [Setting].

The system pops up “Password” prompt box.

Step 2 Input login password and press [OK].

 Note

Default login password is 123456. Please refer to “6.2.5.3 Password Setting” for details.

Step 3 Select “Alarm > Wireless Zone”.

The system displays “Wireless Zone” interface, as shown in Figure 6-9.

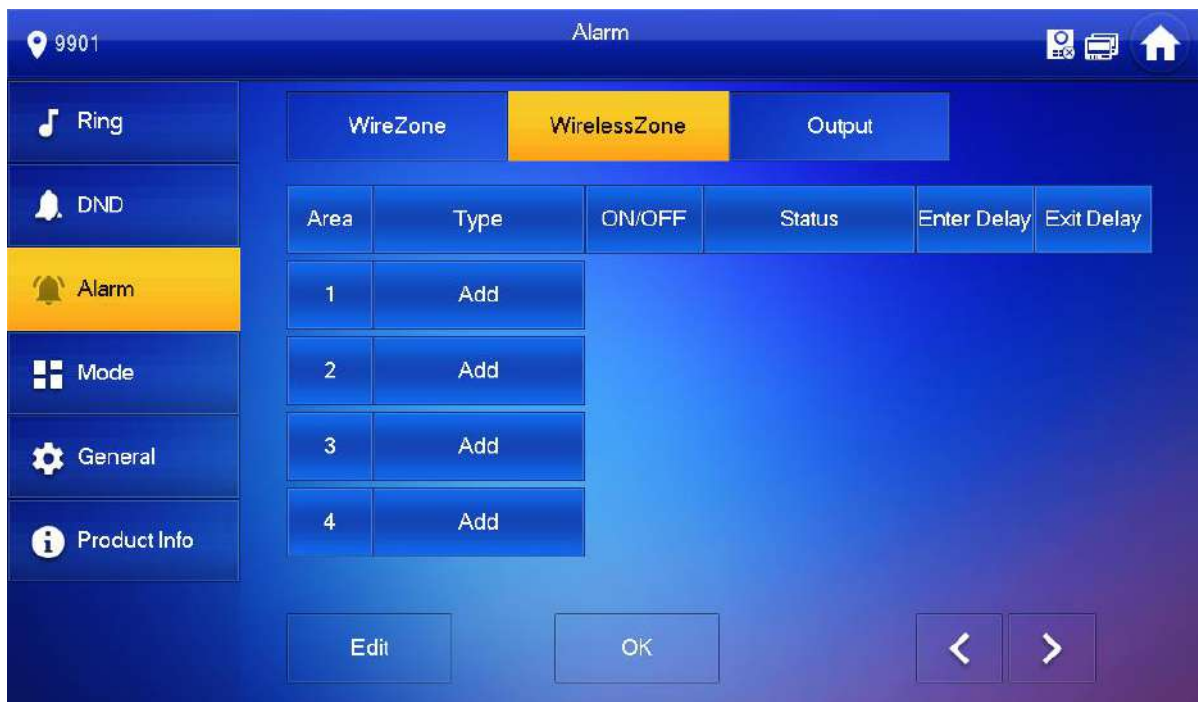

Figure 6-9

Step 4 Press [Add].

Step 5 Press wireless code button of wireless device. Please refer to wireless device user's manual for details.

After successful coding, display zone info.

Step 6 Press corresponding positions to set alarm status, enter delay and exit delay. Please refer to Table 6-2 for details.

Note

Press [Edit] to select a zone and press [Delete] to delete the selected zone.

6.2.3.3 Alarm Output

After enabling alarm output, when other devices call this VTH, the alarm output device will output alarm info.

Step 1 Press [Setting].

The system pops up "Password" prompt box.

Step 2 Input login password and press [OK].

Note

Default login password is 123456. Please refer to "6.2.5.3 Password Setting" for details.

Step 3 Select "Alarm > Output".

The system displays "Output" interface, as shown in Figure 6-10.

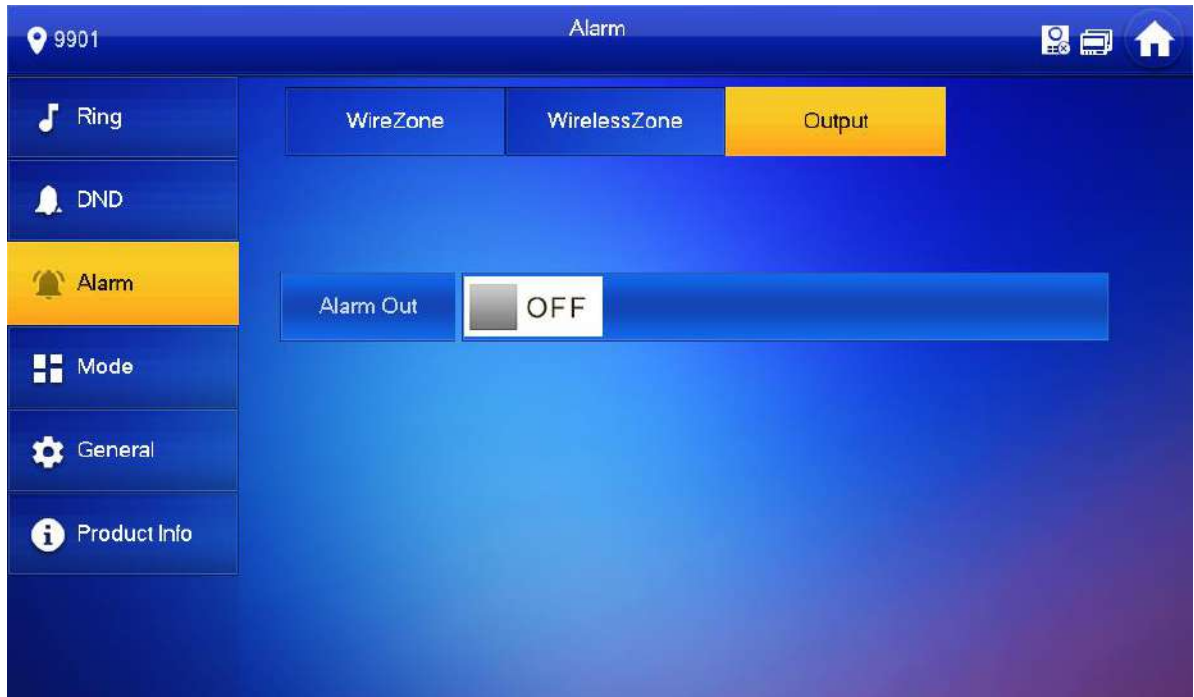



Figure 6-10

Step 4 Press  OFF to enable alarm output function, and the icon becomes .

6.2.4 Mode Setting

Set area on/off status under different modes.



Caution

Area mode can be set only in disarm status.

Step 1 Press [Setting].

The system pops up “Password” prompt box.

Step 2 Input login password and press [OK].



Note

Default login password is 123456. Please refer to “6.2.5.3 Password Setting” for details.

Step 3 Press [Mode].

The system displays “Mode” interface, as shown in Figure 6-11.



Figure 6-11

Step 4 Select arm mode in every tab.

Step 5 Press OFF in every area to add it into arm mode.



Note

Multiple areas can be added into one arm mode simultaneously, whereas one area can be added into different modes.

6.2.5 General Setting

Set VTH time, display, user password and others.

6.2.5.1 Time Setting

Set VTH system time, time zone and DST.



Caution

Parameters at this interface are set on master VTH only, and extension VTH synchronize with master VTH.

Step 1 Press [Setting].

The system pops up “Password” prompt box.

Step 2 Input login password and press [OK].



Note

Default login password is 123456. Please refer to “6.2.5.3 Password Setting” for details.

Step 3 Select “General > Time”.

The system displays “Time” interface, as shown in Figure 6-12.



Figure 6-12

Step 4 Set time parameter.

When system time switch is ON OFF, obtain server time by default; when it is OFF, set system time, time zone and DST manually.

- Manual setting of system time

1. Press ON OFF of system time and the icon becomes OFF, so as to enable manual setting function.
2. Press time text box to set system time.

- Setting of time zone

1. Press ON OFF of system time and the icon becomes OFF, so as to enable manual setting function.
2. Press time zone text box, and select local time zone, as shown in Figure 6-13.

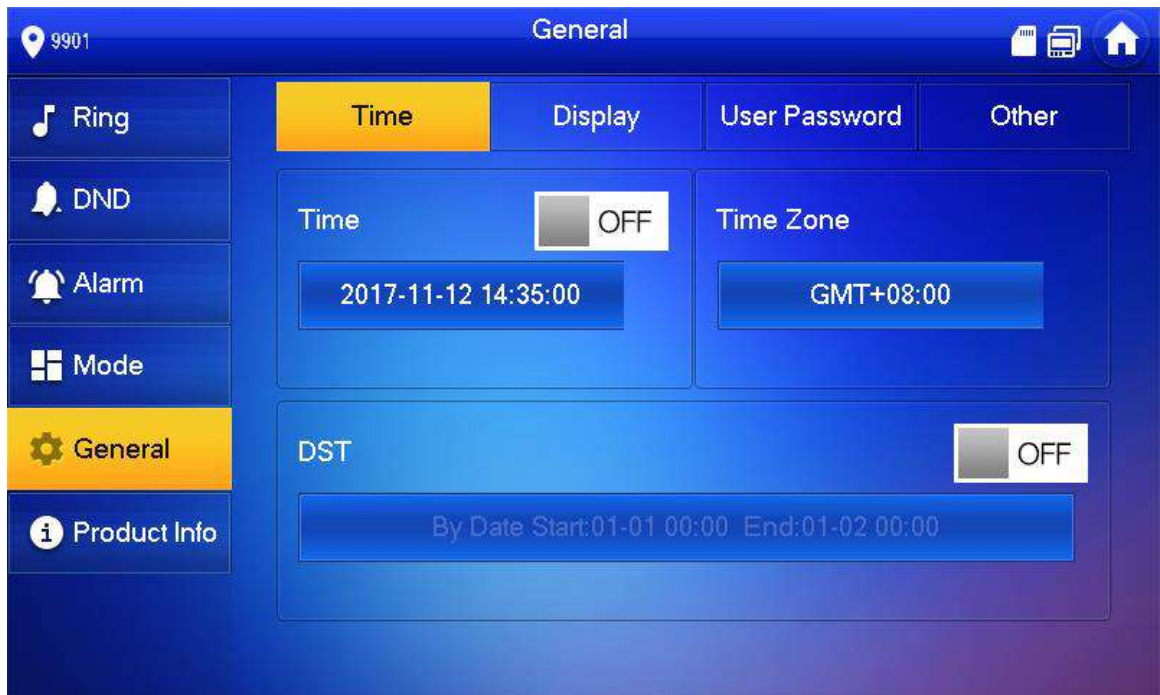

Figure 6-13

- DST setting
 1. Press ON of system time and the icon becomes OFF , so as to enable manual setting function.
 2. Press OFF to enable DST.
 3. Press DST text box, and select DST start time and end time.

6.2.5.2 Display Setting

Set VTH screen brightness, screensaver time and clean.

Step 1 Press [Setting].

The system pops up “Password” prompt box.

Step 2 Input login password and press [OK].

 Note

Default login password is 123456. Please refer to “6.2.5.3 Password Setting” for details.

Step 3 Select “General > Display”.

The system displays “Display” interface, as shown in Figure 6-14.

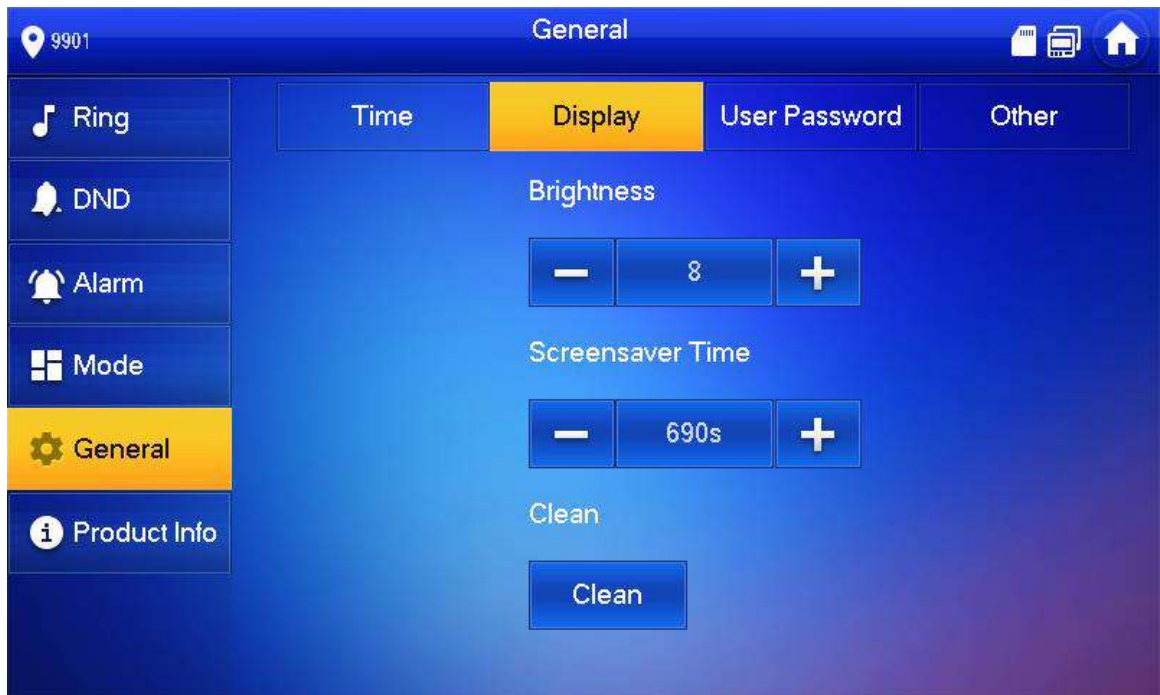



Figure 6-14

Step 4 Set parameters.

- Press  and ; set “Brightness” and “Screensaver Time”.
- Press [Clean] and the screen will be locked for 10 seconds. During the period, clean the screen. It restores after 10 seconds.

6.2.5.3 Password Setting

Set login password, arm/disarm password, unlock password and anti-hijacking password of VTH setting interface. Login password, arm/disarm password and unlock password are 123456 by default, whereas anti-hijacking password is the reversed login password.



Caution

Parameters at this interface are set on master VTH only, and extension VTH synchronize with master VTH.

Step 1 Press [Setting].

The system pops up “Password” prompt box.

Step 2 Input login password and press [OK].

Step 3 Select “General > User Password”.

The system displays “User Password” interface, as shown in Figure 6-15.

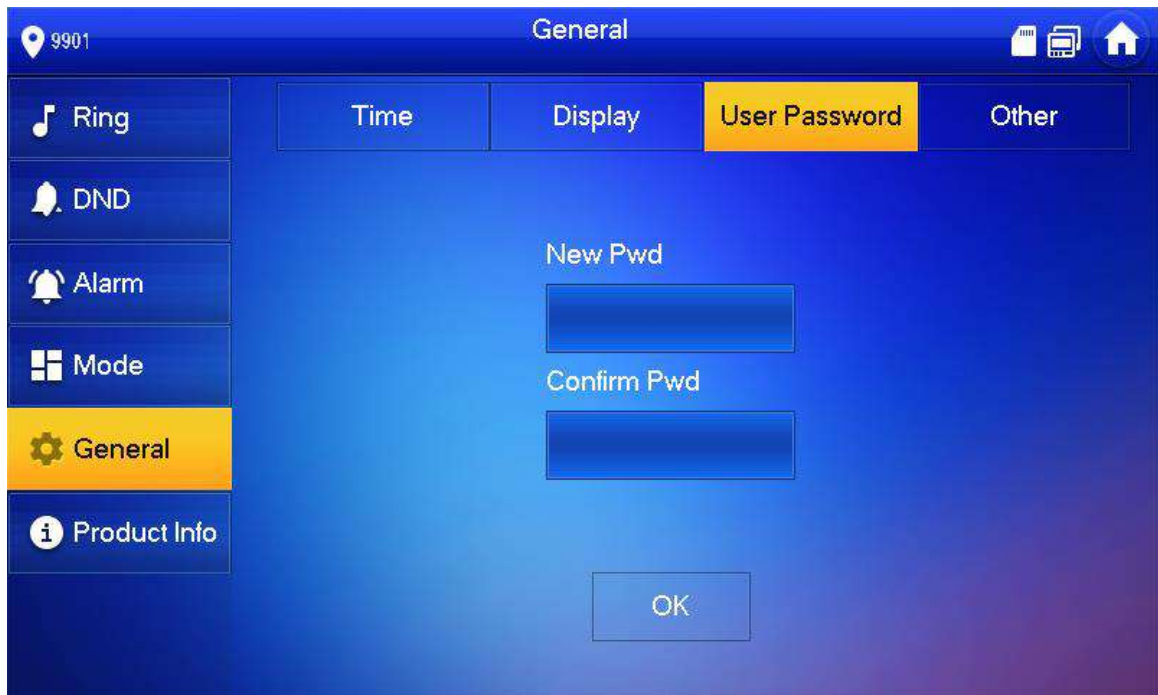

Figure 6-15

Step 4 Enter “New Password” and “Confirm Password”.

Step 5 Press [OK] to complete password modification.

6.2.5.4 Other Settings

Set monitor time, record time, VTO message time, VTO talk time, internal call enable, internal call time, auto capture and touch ring.



Caution

Extension VTH can set “Auto Capture” and “Touch Ring”, but other parameters synchronize with master VTH and cannot be set.

Step 1 Press [Setting].

The system pops up “Password” prompt box.

Step 2 Input login password and press [OK].

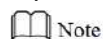

Note

Default login password is 123456. Please refer to “6.2.5.3 Password Setting” for details.

Step 3 Select “General > Other”.

The system displays “Other” interface, as shown in Figure 6-16.

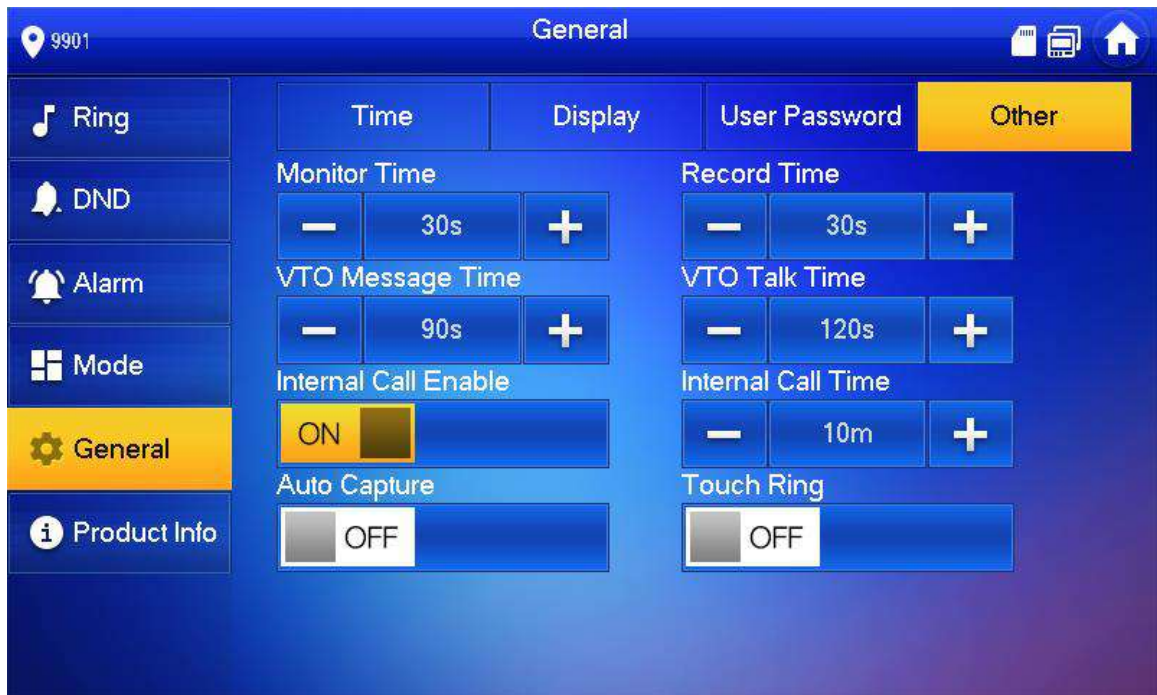





Figure 6-16

Step 4 Set parameters. Please refer to Table 6-3 for details.

Parameter	Description	Operation
Monitor Time	Maximum time to monitor VTO, IPC, fence station, HCVR, NVR and DVR.	
Record Time	Maximum recording time of videos during call, talk, monitoring and speaking. The system stops recording at the end of recording time.	
VTO Message Time	<ul style="list-style-type: none"> When VTO message time is not 0: <ul style="list-style-type: none"> ◇ If VTH with SD card doesn't answer when VTO calls, enter message status according to prompt, and save the message in SD card of VTH. ◇ If VTH doesn't have SD card, but VTO has enabled "Leave Message Upload" and set FTP server, "Message" tab will appear at VTH info interface. If VTH doesn't answer when VTO calls, enter message status according to prompt, and upload the message to FTP server. ◇ If VTH doesn't have SD card, and VTO has not enabled "Leave Message Upload", if VTH doesn't answer when VTO calls, hang up automatically. When VTO message time is 0: <p>Hang up automatically if VTH doesn't answer when VTO calls, no matter whether VTH has SD card or not, no matter whether VTO has enabled "Leave Message Upload" or not.</p> <p> Caution</p> <p>If VTO sets to transfer the call to management center, if VTH doesn't answer when VTO calls, and there is no message prompt, the call will be transferred to management center.</p>	Press  and  to set the time.





Parameter	Description	Operation
Internal Call Time	Maximum talk time between VTH and VTH.	
VTO Talk Time	Maximum talk time when VTO calls VTH.	
Internal Call Enable	After internal call is enabled, VTH can call another VTH.  Caution The called party enables internal call, to realize this function.	Press  OFF to enable the function. The icon becomes  ON.
Auto Capture	After auto capture is enabled, 3 pictures will be captured automatically when VTO calls VTH. View them at “Info> Record and Picture” interface.  Caution This function is valid only when SD card is inserted.	
Touch Ring	After enabling touch ring, there will be a ring when touching the screen.	

Table 6-3

6.2.6 Product Info

Reboot the system and format SD card.

Step 1 Press [Setting].

The system pops up “Password” prompt box.

Step 2 Input login password and press [OK].

 Note

Default login password is 123456. Please refer to “6.2.5.3 Password Setting” for details.

Step 3 Press [Product Info].

The system displays “Product Info” interface, as shown in Figure 6-17.



Figure 6-17

- Reboot
Press [Reboot] and press [OK] at prompt interface. The device will reboot.
- SD Format
Press [SD Format] and press [OK] at prompt interface. The SD card will be formatted.



Caution

Before format, ensure that SD card has been inserted into the device. Otherwise, the function is invalid.

6.3 Project Settings

6.3.1 Forget Password

If you forget initialization password when entering project settings interface, reset password through “Forget Password” at the interface or in VDPconfig tool.

6.3.1.1 Reset the Password at the Interface

- Step 1 Press [Setting] for over 6 seconds.
The system pops up “Password” prompt box.
- Step 2 Press [Forget Password].
The system displays “QR Code” interface, as shown in Figure 6-18.

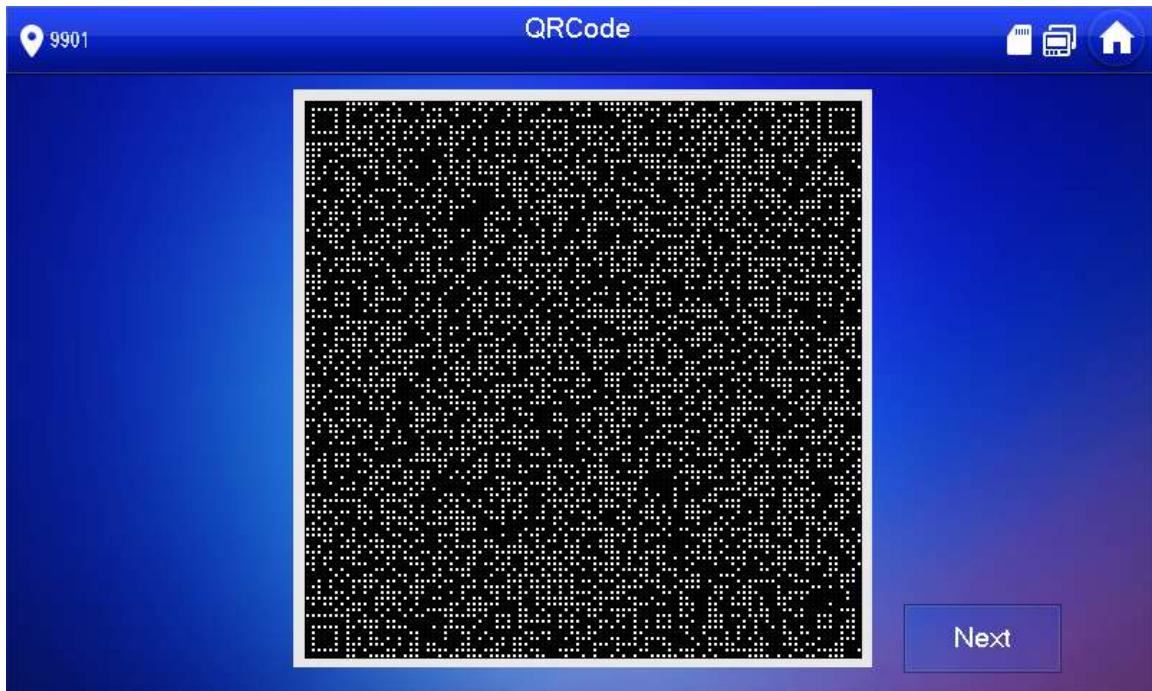

Figure 6-18

- Step 3 Scan the QR code with any code-scanning APP, bind your email box, send the scanning results to 10690546980662 with short message, and thus obtain security code.
- Step 4 Press [Next].
- Step 5 Enter “Password”, “Confirm Password” and obtained “Security Code”.
- Step 6 Press [OK] to complete resetting the password.

6.3.1.2 Reset the Password in VDPconfig

Use VDPconfig tool to export XML file (ExportFile.xml), send it by email to support_cpwd@htmicrochip.com, and obtain XML file (result.xml). Then, import the file and reset a new password.



Note

Please refer to “VDPconfig Help Document” for details.

6.3.2 Network Settings

Set VTH network info according to actual conditions, since different types of devices support different access modes.



Note

IP addresses of VTH and VTO shall be in the same network segment. Otherwise, VTH will fail to obtain VTO info after configuration.

- Step 1 Press [Setting] for over 6 seconds.
The system pops up “Password” prompt box.
- Step 2 Enter the password set during initialization, and press [OK].
- Step 3 Press [Network].
The system displays “Network” interface, as shown in Figure 6-19 and Figure 6-20.



Only devices with the wireless function can access to wireless network.

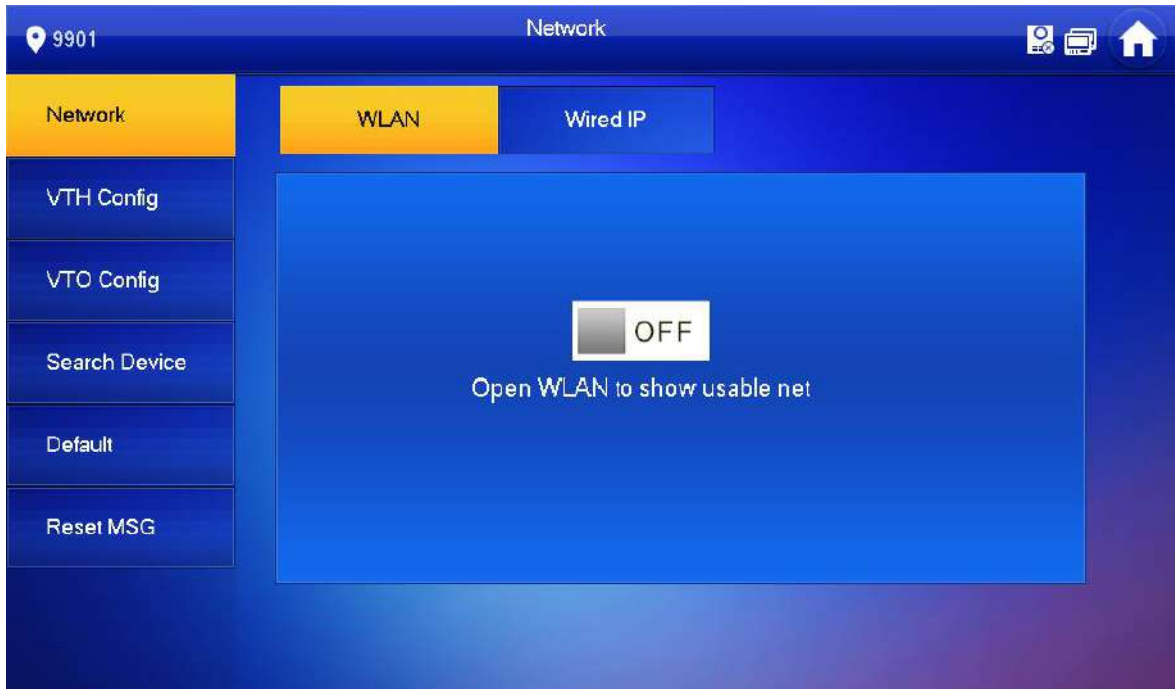

Figure 6-19



Figure 6-20

Step 4 Set according to actual network access mode.

- Wired IP

Enter “Local IP”, “Subnet Mask” and “Gateway”, press [OK]. Or press OFF to enable DHCP function and obtain IP info automatically.



If the device has wireless function, please click “Wired IP” tab to set it.

- WLAN

1. Press OFF to enable WIFI function.

The system displays available WIFI list, as shown in Figure 6-21.

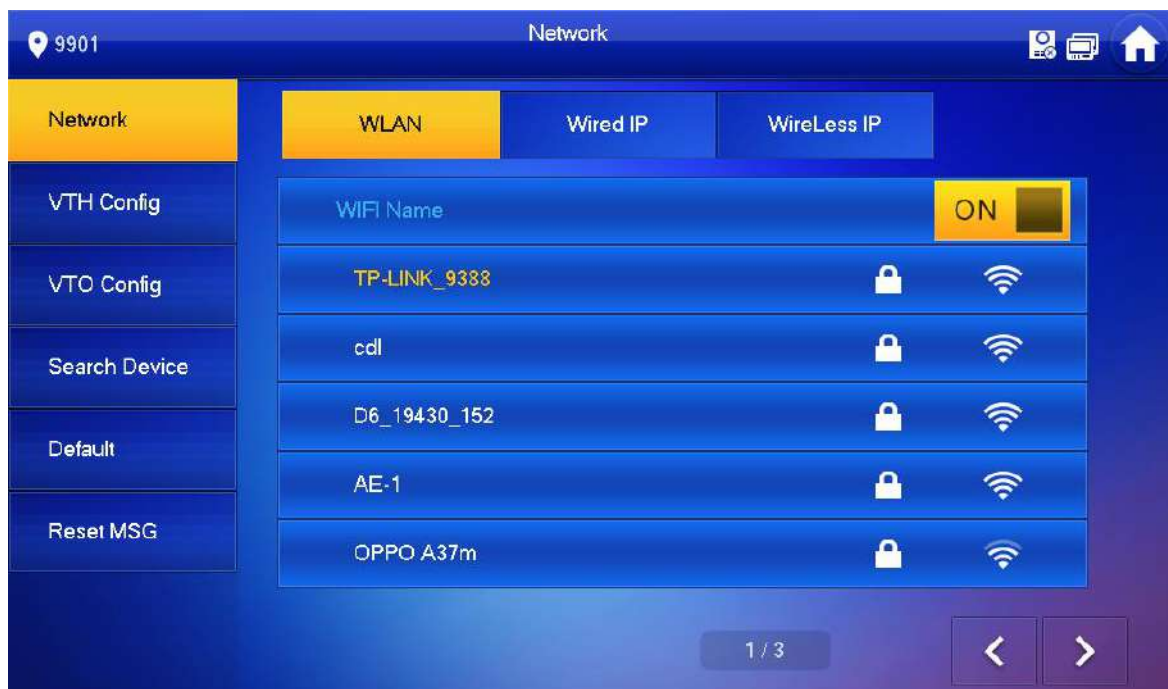

Figure 6-21

2. Connect WIFI.

The system has 2 access ways as follows.

- ◇ At "WLAN" interface, select WIFI, click "Wireless IP" tab to enter "Local IP", "Subnet Mask" and "Gateway", and press [OK].
- ◇ At "WLAN" interface, select WIFI, click "Wireless IP" tab, press OFF to enable DHCP function and obtain IP info automatically, as shown in Figure 6-22.

 Note

To obtain IP info with DHCP function, use a router with DHCP function.



Figure 6-22

6.3.3 VTH Config

Configure VTH info.



VTH “Room No.” shall be the same with “VTH Short No.”, which is set at VTO WEB interface or H500 platform server.

- Step 1 Press [Setting] for over 6 seconds.
The system pops up “Password” prompt box.
- Step 2 Enter the password set during initialization, and press [OK].
- Step 3 Press [VTH Config].
The system displays “VTH Config” interface, as shown in Figure 6-23.



Figure 6-23

Step 4 Set VTH info.

- Be used as a master VTH.
Enter “Room No.” (such as 9901).

 Note

“Room no.” shall be the same with “VTH Short No.”, which is set when adding VTH at WEB interface. Otherwise, it will fail to connect VTO.

- Be used as an extension VTH.
 1. Press [Master] and switch to “Extension”.
 2. Enter “Room No.” (such as 9901-1) and “Master IP” (IP address of master VTH).

 Note

“User Name” and “Password” are the user name and password of master VTH. Default user name is admin, and the password is the one set during initialization.

Step 5 Press [OK] to save settings.

6.3.4 VTO Config

Add VTO and fence station info, and bind VTH with VTO on the VTH side.

Step 1 Press [Setting] for over 6 seconds.

The system pops up “Password” prompt box.

Step 2 Enter the password set during initialization, and press [OK].

Step 3 Press [VTO Config].

The system displays “VTO Config” interface, as shown in Figure 6-24.



Figure 6-24

Step 4 Enter main VTO/Sub VTO name, IP address, “User Name” and “Password”. Switch the “Enable Status” to .

 Note

- Press left and right arrows to switch VTO config tab.
- Sub VTO shall select device type, which is “Door” by default. When fence station is selected, configure VTO middle no. (which is VTO no.) and obtain IP address automatically.
- “User Name” and “Password” shall be the same as the user name and password to login VTO WEB. Otherwise, it will fail to connect.

Step 5 Press [OK] to save settings.

6.3.5 Search Device

Search online devices in the same network segment with VTH, add, modify IP and delete it. After adding successfully, this VTO can call VTH.



Caution

Support to modify IP address of villa VTO, rather than IP address of unit VTO.

Step 1 Press [Setting] for over 6 seconds.

The system pops up “Password” prompt box.

Step 2 Enter the password set during initialization, and press [OK].

Step 3 Press [Search Device].

The system displays “Search Device” interface, as shown in Figure 6-25.



Figure 6-25

6.3.5.1 Search Device

Press [Refresh] to refresh device list; press  to view the device.

6.3.5.2 Modify IP

Step 1 Select the needed VTO and press [Modify IP].
The system displays “Modify VTO IP” interface, as shown in Figure 6-26.

 Note

If “Modify IP” is gray, it means that this device is unit VTO whose IP cannot be modified.

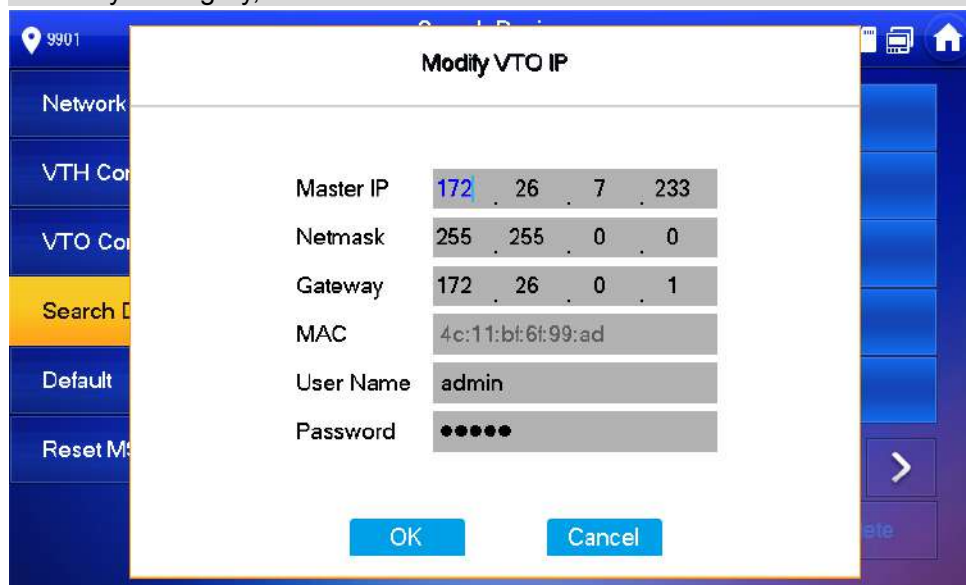

Figure 6-26

Step 2 Fill in “Master IP”, “Netmask”, “Gateway”, “User Name” and “Password” of the VTO.



“User Name” and “Password” are the user name and password to login VTO WEB interface.

Step 3 Press [OK] to save the settings.

6.3.5.3 Add Manually

Step 1 Select the needed VTO and press [Add].

The system displays “Add VTO” interface, as shown in Figure 6-27.

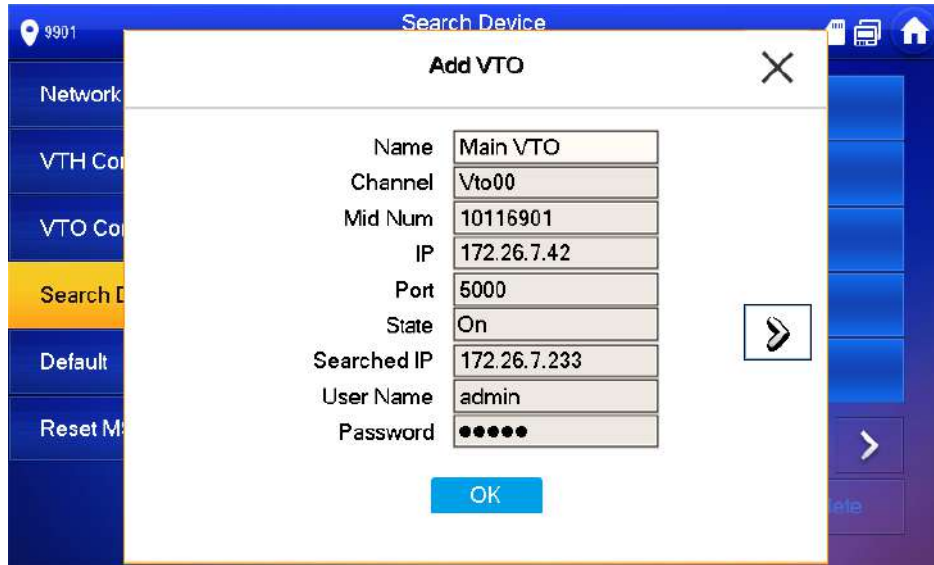

Figure 6-27

Step 2 Enter “Name”, “User Name” and “Password”, and set “Status” to be “On”.



“User Name” and “Password” are the user name and password to login VTO WEB interface.

If it is a sub VTO, press  to page down.

Step 3 Press [OK] to complete configuration.

After successful configuration, this VTO can call VTH.

6.3.5.4 Delete Device

Select a VTO that has been added, and press [delete] to delete it.



After deletion, this VTO info in WEB interface will be deleted too. In order to use it again, this VTO shall be added again.

6.3.6 Default

All parameters of the device, except IP address, can be restored to initial default values.

Step 1 Press [Setting] for over 6 seconds.

The system pops up “Password” prompt box.

Step 2 Enter the password set during initialization, and press [OK].

Step 3 Press [Default].

The system displays “Default” interface.

Step 4 Press [OK].

The device reboots and enters initialization interface, representing successful restoration.

6.3.7 Reset MSG

Modify the bound Email.

Step 1 Press [Setting] for over 6 seconds.

The system pops up “Password” prompt box.

Step 2 Enter the password set during initialization, and press [OK].

Step 3 Press [Reset MSG].

The system displays “Reset MSG” interface, as shown in Figure 6-28.

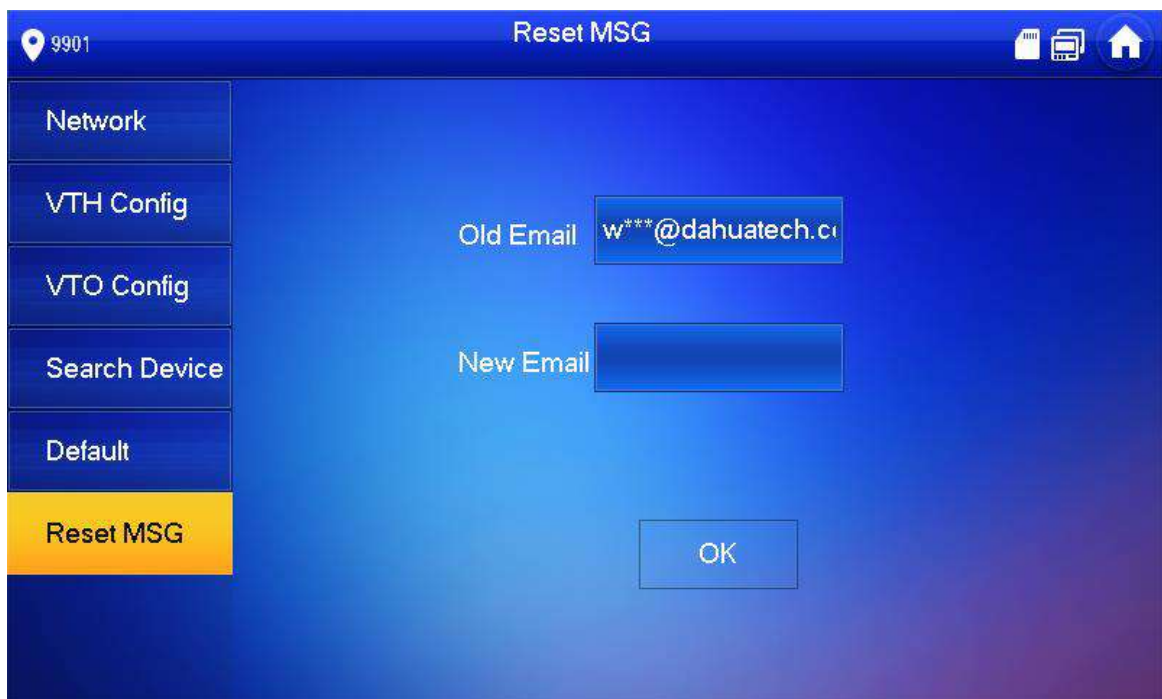

Figure 6-28

Step 4 Enter “New Email” and press [OK].

 Note

The Email will obtain security code during password resetting. For details, please refer to “6.3.1 Forget Password”.

6.4 Call

Manage contact, call users and view the latest call log.

6.4.1 Contact

Add and edit VTH and extension number.

Select “Call > Contact”, and the system displays “Contact” interface, as shown in Figure 6-29.

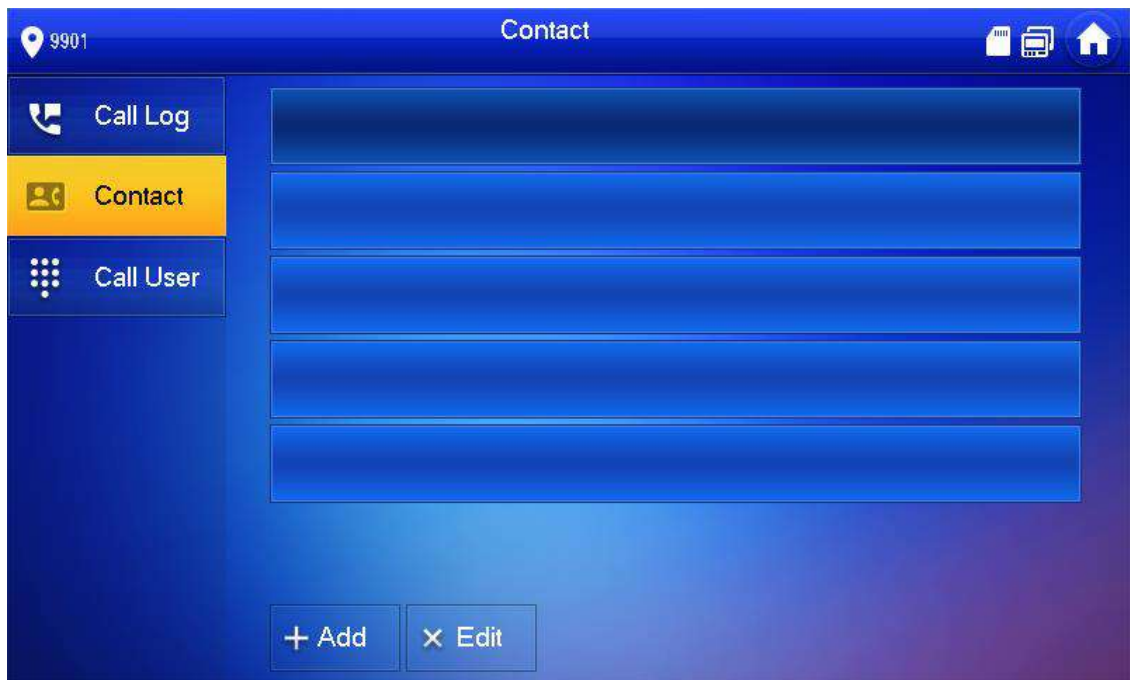

Figure 6-29

6.4.1.1 Add User

Step 1 Press [Add].

The system displays “User Info” interface, as shown in Figure 6-30.

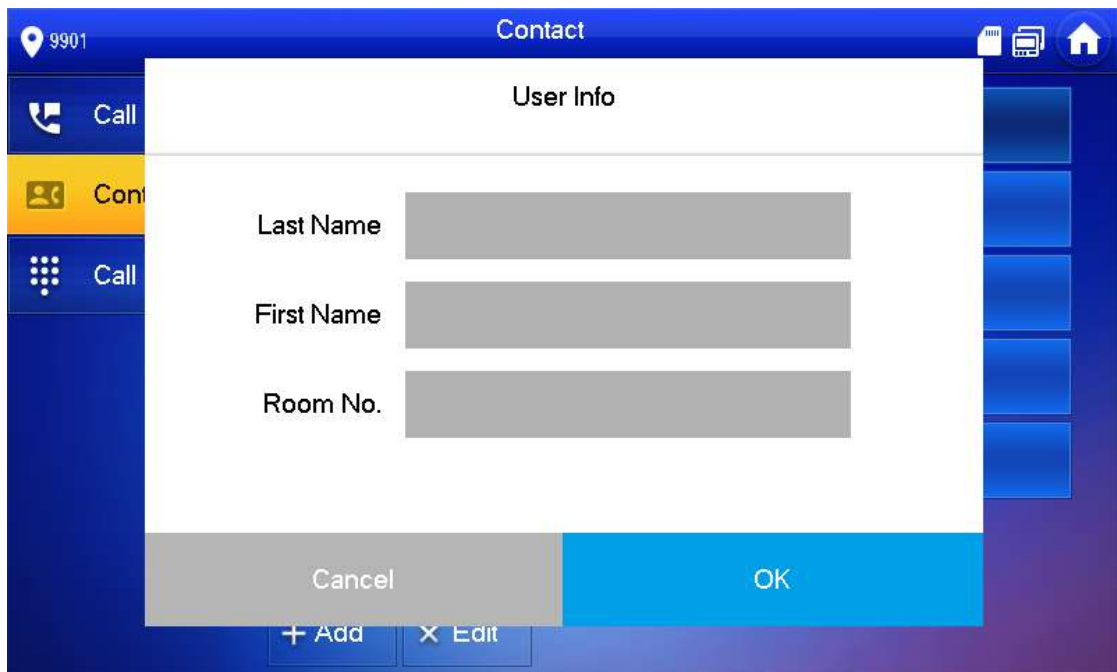



Figure 6-30

Step 2 Enter “Last Name”, “First Name” and “Room No.” of contact person.

Step 3 Press [Save] to complete adding.

6.4.1.2 Edit Contact Info

Select the contact person, press  to edit the info.

6.4.1.3 Delete Contact Person

Press [Edit], select the contact person and press [Delete] to delete the contact person.

 Note

Multiple contact persons can be selected once.

6.4.2 Call User

 Note

- Make sure that internal call function has been enabled. Please refer to “6.2.5.4 Other Settings” for details.
- Call function is used by VTH to call VTH.
- If both VTHs have a camera, bilateral video call can be provided.

6.4.2.1 Dial and Call User directly

At “Call User” interface, dial and call the user.

Step 1 Select “Call > Call User”.

The system displays “Call User” interface, as shown in Figure 6-31.



Figure 6-31

Step 2 Enter the user’s room no. (VTH room no.).

- In case of continuous dialing rule,
 - ◇ Call a user in the same building, dial 4-digit room number directly.
 - ◇ Call a user in other buildings, add the building number. For example, dial

1-9901 to call Building 1 Room 9901.

- In case of discontinuous dialing rule,
 - ◇ Call a user in the same building and the same unit, dial 4-digit room number directly.
 - ◇ Call a user in other buildings or other units, add the building number and unit number. For example, dial 1-1-9901 to call Building 1 Unit 1 Room 9901.

 Note

- If master VTH (9901) calls extension (9901-1), please enter room no.: -1; if the extension calls master VTH, please enter room no.: 9901.
- Dialing rule is set in “Product Info” at VTO WEB interface.

Step 3 Press  to start.

The system displays calling interface, as shown in Figure 6-32. After the user answers the call, both parties talk to each other, as shown in Figure 6-33. For interface key description, please refer to Table 6-4.

 Note

If VTH owns a camera, there will be videos after answering the call.

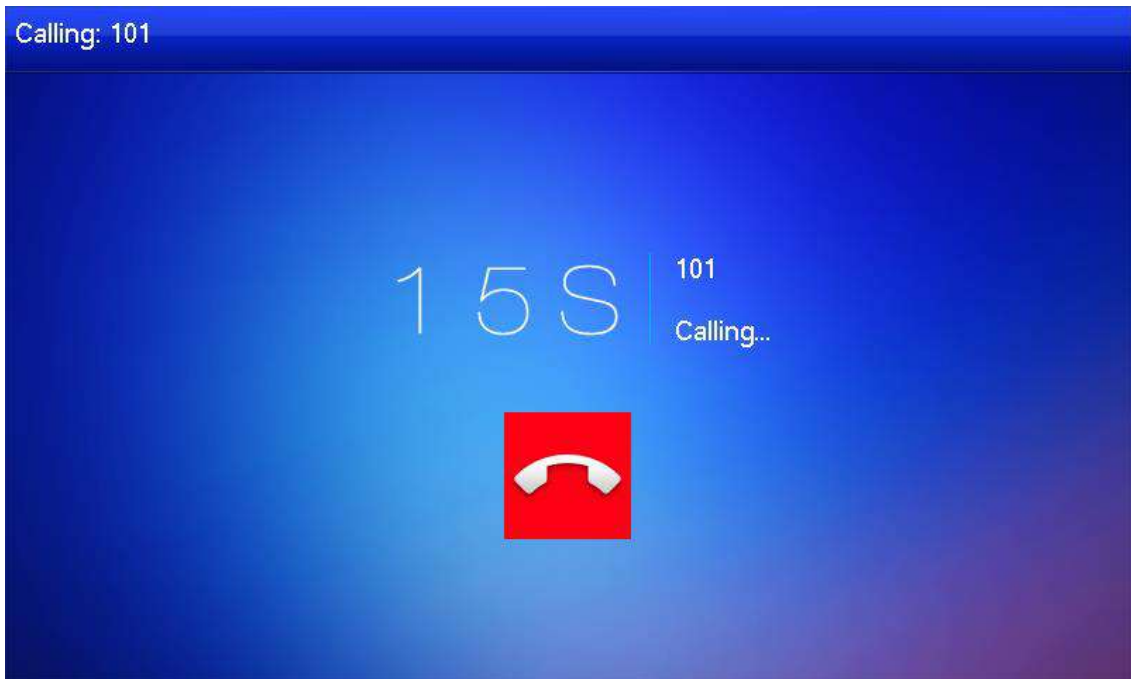

Figure 6-32

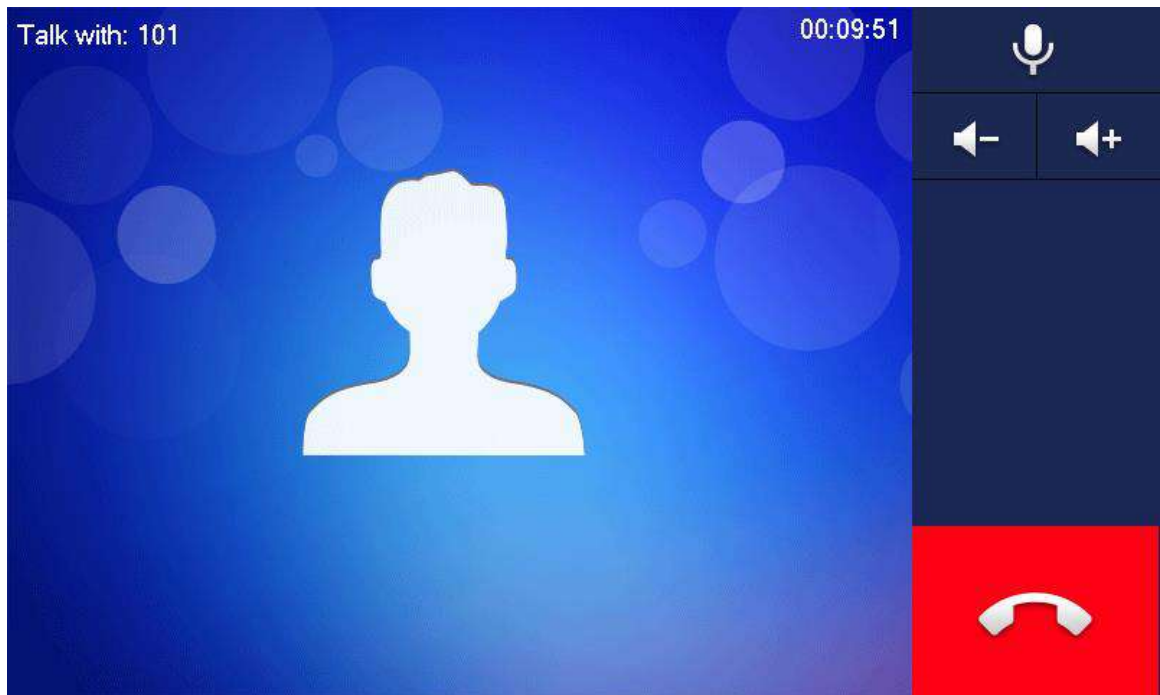

Figure 6-33

6.4.2.2 Call User in Contact



Caution

Please add contact persons to the contact, by reference to “6.4.1.1 Add User”.

Step 1 Select “Call > Contact”.

Step 2 Select the one you want to call.



Step 3 Press  to start.

6.4.3 Call from User

When another VTH calls this VTH, the call interface will be displayed, as shown in Figure 6-34.



Figure 6-34

- Press  to talk with each other, as shown in Figure 6-35. For key description, please refer to Table 6-4.
- Press  to hang up.

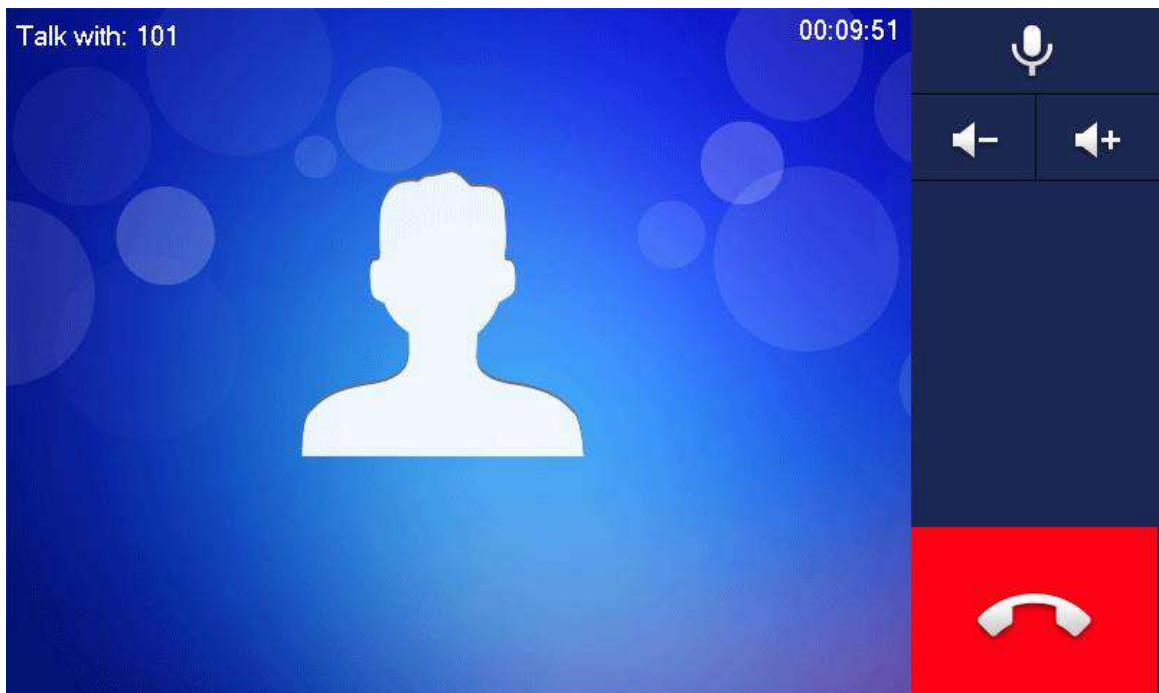

Figure 6-35

6.4.4 Call from VTO

- Step 1 Dial VTH room no. (such as 9901) at VTO, to call VTH.
VTH pops up a waiting picture, as shown in Figure 6-36.
- Step 2 At VTH interface, press [Answer].

Answer the call and talk with each other. For key description, please refer to Table 6-4.

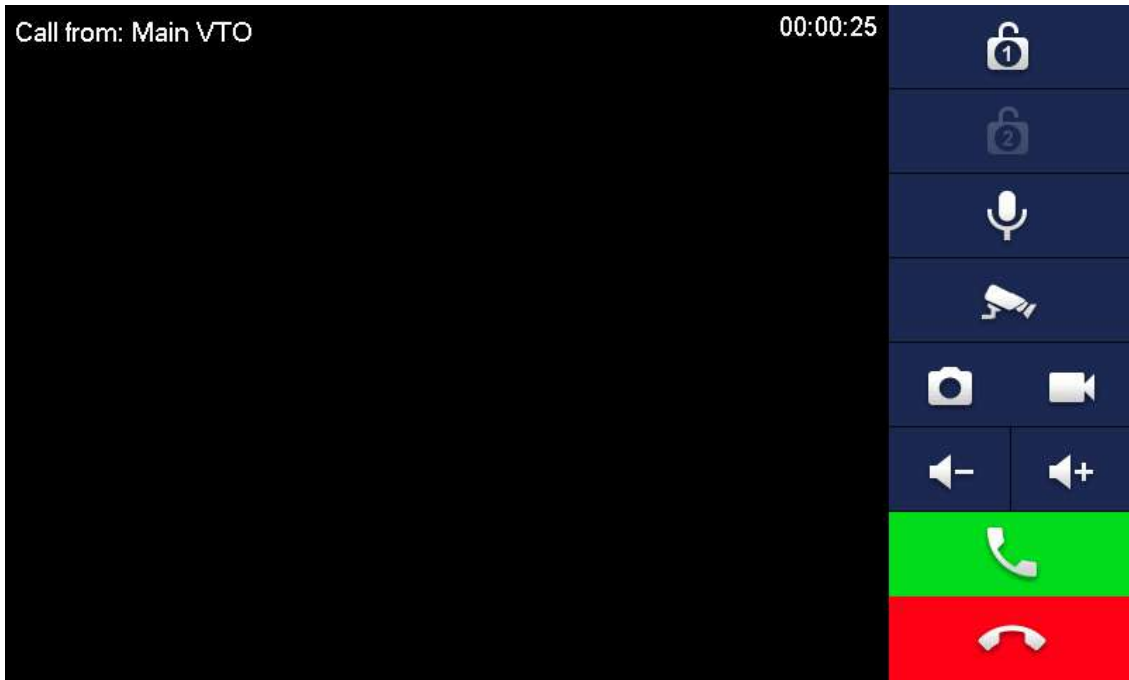

Figure 6-36

Key	Description
	<p>Press this key to unlock the VTO remotely.</p> <p> Note The system provides 2-channel unlock function. If the icon is gray, it means that unlock function of this channel is not available.</p>
	<p>This key means to talk with the opposite end device.</p> <p>Press this key to prohibit talking; press it again to switch back to talking status.</p>
	<p>Press this key to select IPC that shall be monitored.</p>
	<p>Press this key to snapshot.</p> <p> Note This key is gray if SD card is not installed.</p>
	<p>Press this key to record. Complete recording when the call is completed or by pressing .</p> <p>Videos are stored in SD card of this VTH. If SD card is full, the earlier videos will be covered.</p> <p> Note This key is gray if SD card is not installed.</p>
	<p>Press this key to reduce volume.</p>
	<p>Press this key to increase volume.</p>
	<p>Press this key to answer and talk.</p>
	<p>Press this key to refuse.</p>

Table 6-4

6.4.5 Call Log

View and manage the missed call, accepted call and called log of this VTH. Meanwhile, call back and save info about the contact persons.

Select “Call > Call Log”, and the system displays “Call Log” interface, as shown in Figure 6-37.

 Note

- In case of missed call, press  on the front panel and enter call log interface.
- If contact person is VTO, callback is not available.



Figure 6-37

6.4.5.1 Callback

Select the required VTH log, press [Call] to call the contact person.

6.4.5.2 Delete

Press [Edit], select a log and press [Delete] to delete it.

6.4.5.3 Clear

Press [Clear] to clear all logs in this tab.

6.5 Monitor

VTH is able to monitor VTO, fence station or IPC.

6.5.1 Monitoring of VTO



Caution

Please confirm user name and password in VTH, which are set when adding VTO. They shall be consistent with WEB login user name and password of VTO. Otherwise, it will fail to obtain videos during monitoring.

VTH is able to monitor VTO or fence station. Under the condition of monitoring, press call key  on the front panel to talk to VTO. VTO will pick up the call automatically.

Step 1 Select “Monitor> VTO”.

The system displays the list of added VTO and fence station, as shown in Figure 6-38.

Press  to add frequently-used VTO or fence station to favorites, which will be displayed in “Favorite” tab, so as to switch videos during monitoring.

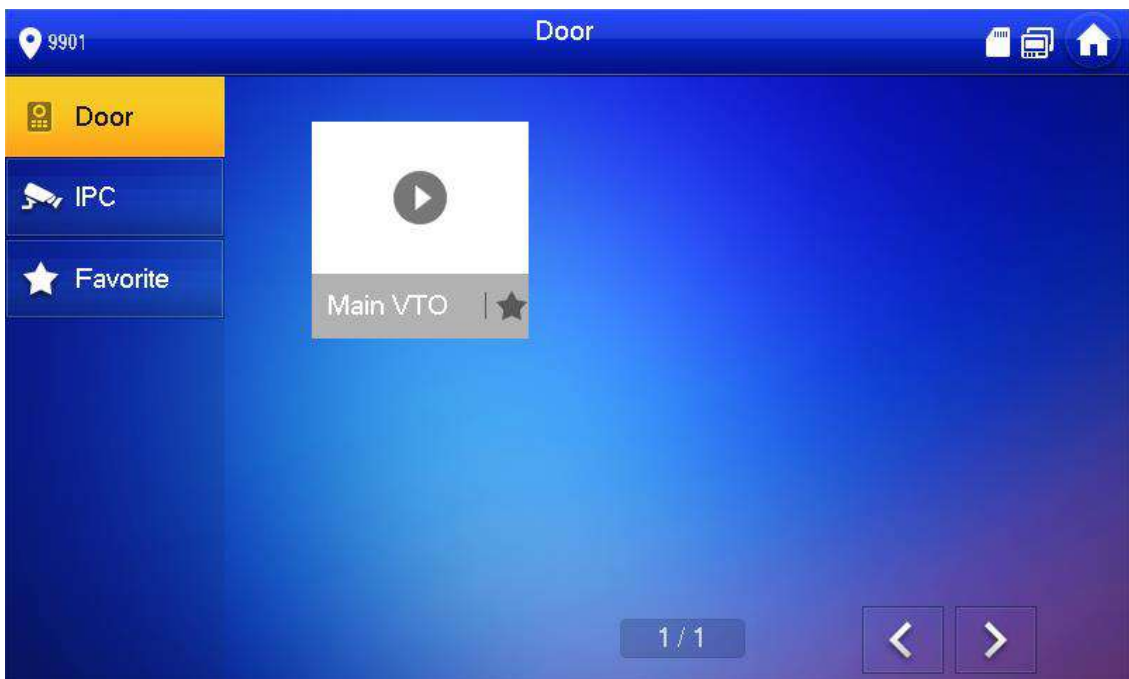

Figure 6-38

Step 2 Press  to select VTO that shall be monitored.

The device enters monitoring, as shown in Figure 6-39. For relevant monitoring operations, please refer to Table 6-5.

 Note

Speak to VTO directly after successful monitoring.

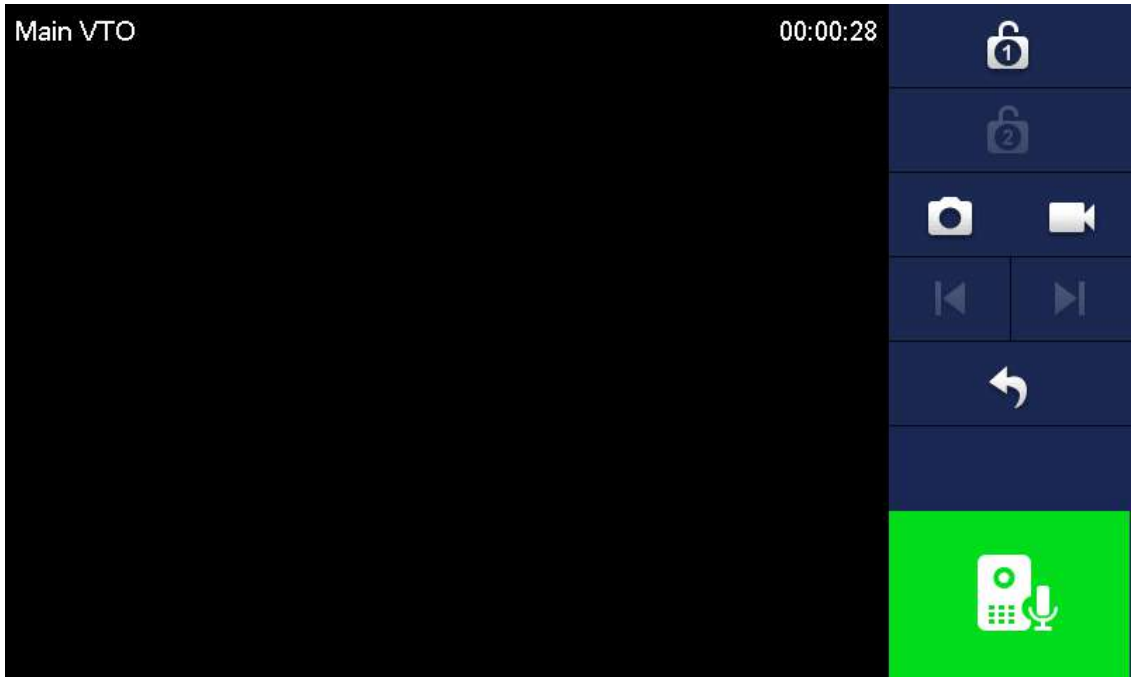

Figure 6-39

Icon	Description
	<p>Press this key to unlock VTO remotely.</p> <p> Note The system provides 2-channel unlock function. If the icon is gray, it means that unlock function of this channel is not available.</p>
	<p>Press this key to snapshot.</p> <p> Note This key is gray if SD card is not installed.</p>
	<p>Press this key to record. Complete recording when the call is completed or by pressing .</p> <p>Videos are stored in SD card of this VTH. If SD card is full, the earlier videos will be covered.</p> <p> Note This key is gray if SD card is not installed.</p>
	<p>If VTH connects multiple VTO/IPC, press and to switch to last/next channel.</p>
	<p>Press this key to cancel monitoring.</p>
	<p>Press this key to speak to the other end device.</p> <p>Press this key to start and the icon becomes . Press it again to complete.</p>

Table 6-5

6.5.2 Monitoring of IPC



Caution

Please add IPC before monitoring of IPC.

6.5.2.1 Add IPC



Note

- IPC added at main VTO and H500 “IPC” interface will be synchronized to VTH. The synchronized IPC cannot be deleted.
- Before adding IPC, please ensure that IPC has been powered on, and connected to the same network with VTH.

Step 1 Select “Monitor> IPC”.

The system displays “IPC” interface, as shown in Figure 6-40. Press  to add frequently-used IPC to favorites, which will be displayed in “Favorite” tab, so as to switch videos during monitoring.

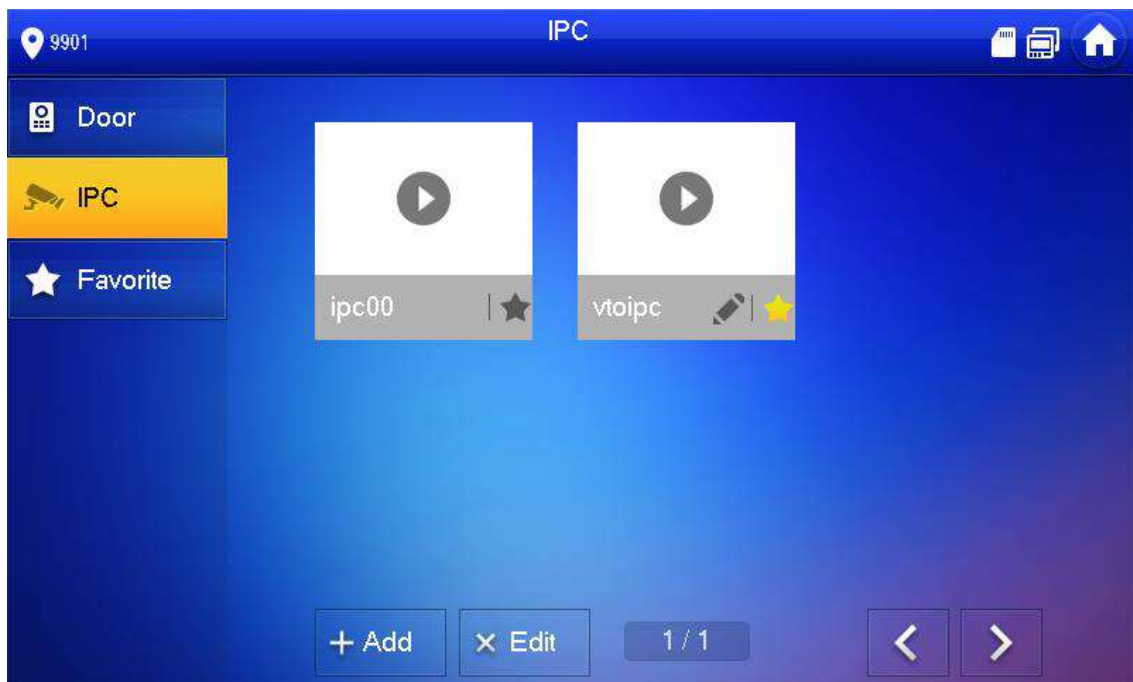

Figure 6-40

Step 2 Press [Add].

The system displays “Add IPC” interface, as shown in Figure 6-41.

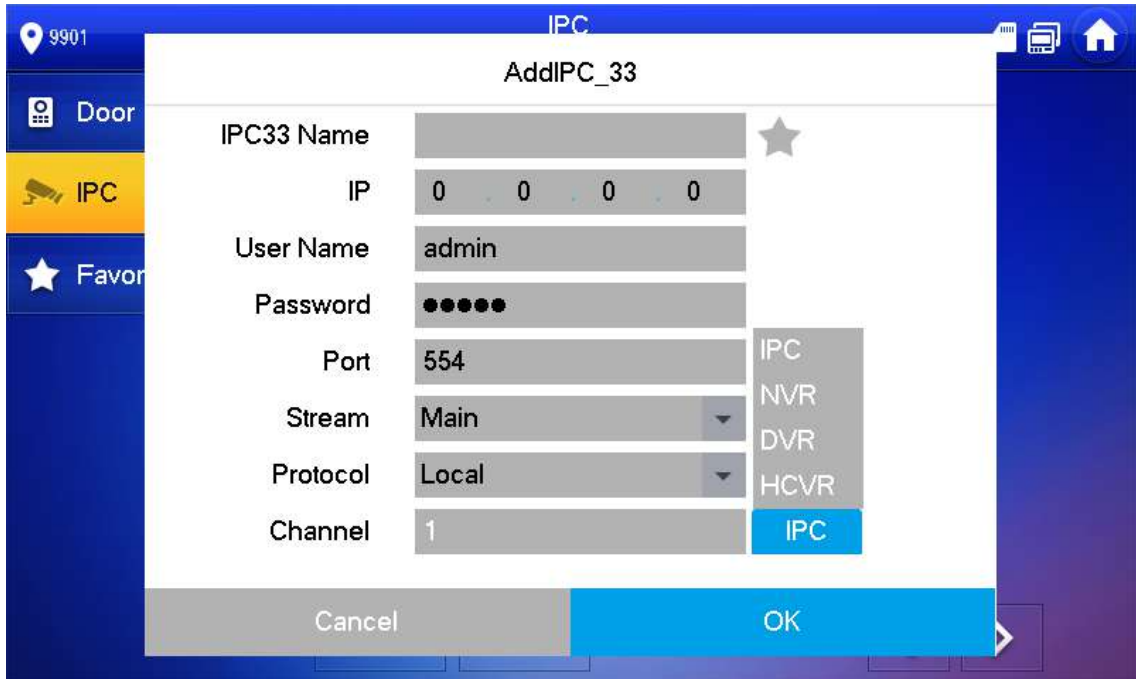

Figure 6-41

Step 3 Please refer to Table 6-6 to configure camera parameters.

Parameter	Description
IPC	<p>Press this key to select IPC, NVR, DVR and HCVR.</p> <ul style="list-style-type: none"> • Select IPC, meaning that VTH obtains video stream from the connected IPC directly. It is necessary to configure IPC info. • Select NVR/DVR/HCVR, meaning that VTH obtains IPC video stream from the connected device. It is necessary to configure info about the connected device.
IPC33 Name	Input IPC/NVR/DVR/HCVR name.
IP	Input IP address of the connected IPC/NVR/DVR/HCVR.
User Name	Input user name and password to login WEB interface of IPC/NVR/DVR/HCVR.
Password	
Port	Default port is 554.
Stream	<p>Select stream type according to needs, including main stream and extra stream.</p> <ul style="list-style-type: none"> • Main stream: large stream, high definition, large occupied bandwidth, suitable for local storage. • Extra stream: relatively smooth image, small occupied bandwidth, suitable for network transmission with low bandwidth.
Protocol	It includes local protocol and Onvif protocol. Please select according to the protocol of the connected device.
Channel	<p>If IPC is connected, default setting is 1.</p> <p>If NVR/XVR/HCVR is connected, set channel number of IPC on NVR/XVR/HCVR.</p>

Table 6-6

Step 4 Press [OK] to finish.

6.5.2.2 Modify IPC

Modify IPC info.

Step 1 Select “Monitor> IPC”.

The system displays “IPC” interface.

Step 2 Press  of IPC.

Step 3 Modify IPC parameters. Please refer to Table 6-6 for details.

Step 4 Press [OK] to finish.

6.5.2.3 Delete IPC

Delete IPC that has been added. However, IPC synchronized from VTO or the platform cannot be deleted.

Step 1 Select “Monitor> IPC”.

The system displays “IPC” interface.

Step 2 Press [Edit].

Step 3 Select IPC.

Step 4 Press [Delete] to delete the selected IPC.

6.5.2.4 Monitor IPC

Monitor the IPC.

Step 1 Select “Monitor> IPC”.

The system displays “IPC” interface.

Step 2 Select IPC to be monitored, and press .

The system displays monitoring interface, as shown in Figure 6-42.

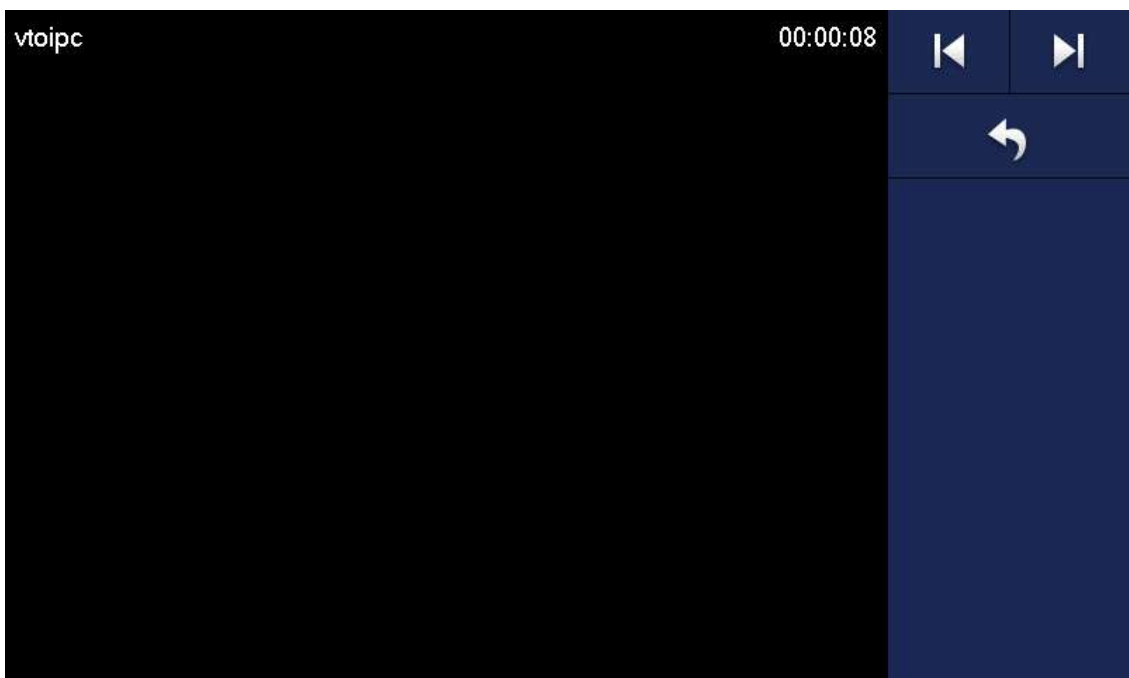

Figure 6-42

Step 3 Please monitor the VTO by reference to Table 6-5.

6.5.3 Favorite

Display VTO, fence stations or IPC that have been added to favorites.



To view favorite list, please ensure that VTO, fence station or IPC have been added to favorites. Otherwise, the list is null.

Step 1 Select “Monitor> Favorite”.

The system displays “Favorite” interface, as shown in Figure 6-43.

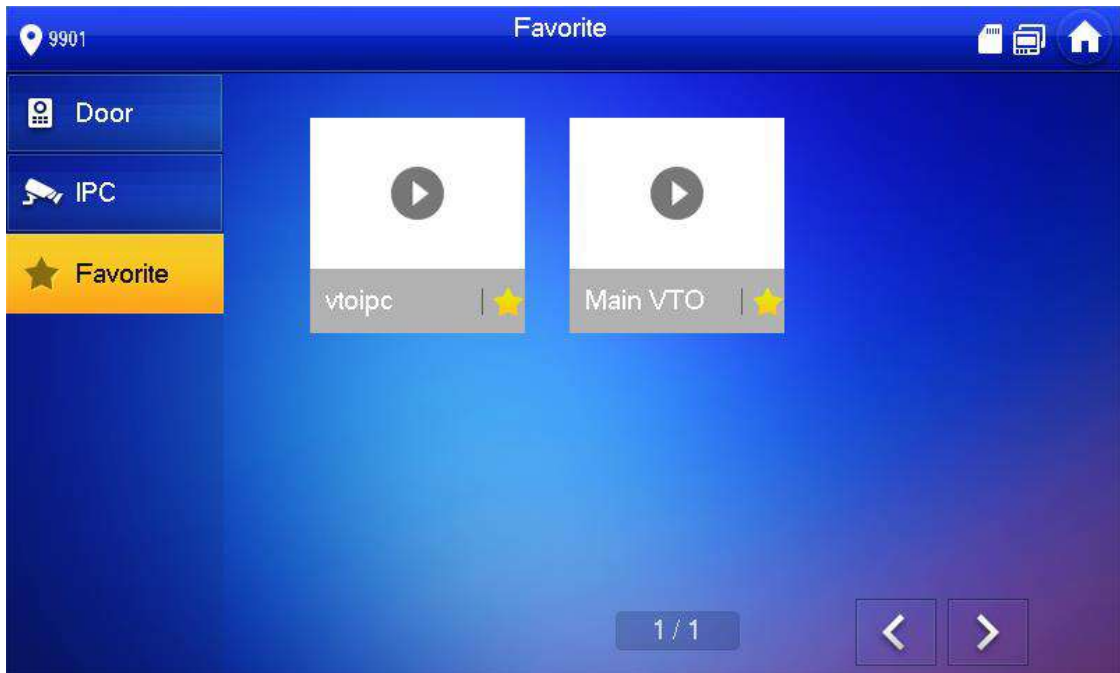





Figure 6-43

Step 2 Select the device to be monitored, and press .

The system displays monitoring interface. In case of multiple devices in “Favorite” tab,

press  /  to switch and monitor them.

6.6 SOS



Please ensure that management center has been connected. Otherwise, it will fail to call.

In emergency, press **SOS** button on the front panel, or press [SOS] at the main interface to call management center.

6.7 Info

6.7.1 Alarm



All alarm info is stored in the device.

When an alarm is triggered, there will be 15s alarm sound. Pop up alarm prompt interface, as shown in Figure 6-44, and upload the alarm info to alarm record interface and management platform.

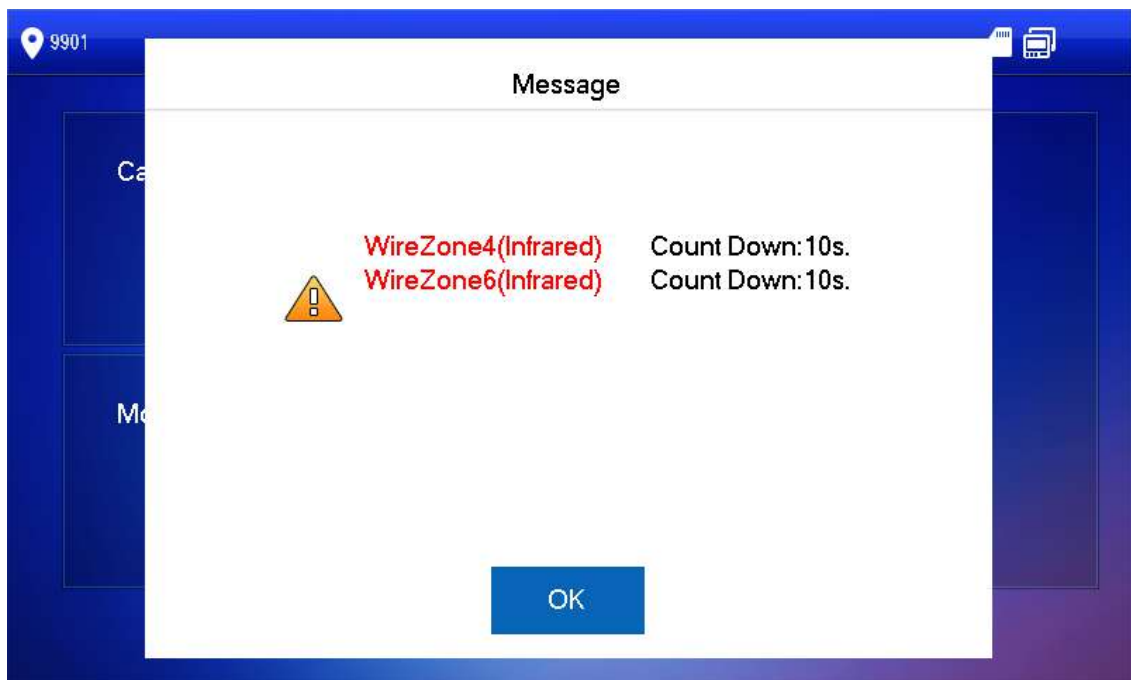

Figure 6-44

Alternatively, select “Info > Alarm”, and the system displays “Alarm” interface, as shown in Figure 6-45. “All” tab displays all alarm info of the system, whereas “Unread” tab displays unread alarm info.

- Press [Edit] to select the info; press [Delete] to delete the selected info.
- Press [Clear] to delete all records after confirmation.



Figure 6-45

6.7.2 Guest Message



- When a SD card is inserted into the device, this function is valid. All messages are stored in SD card.
- If SD card is not inserted, but VTO WEB has set FTP and selected "Video-audio Message Uploading", this function is valid too. All messages will be uploaded to FTP.

Select "Info > Guest Message", and the system displays "Guest Message" interface, as shown in Figure 6-46. "All" tab displays all messages of the system, whereas "Unread" tab displays unread messages.

- Press [Edit] to select the info; press [Delete] to delete the selected info.
- Press [Clear] to delete all messages after confirmation.



Figure 6-46

6.7.3 Publish Info



Caution

Info released by the management center is stored in the device, and pictures, if any, are stored in SD card.

Select “Info > Publish Info”, and the system displays “Publish Info” interface, as shown in Figure 6-47. “All” tab displays all info of the system, whereas “Unread” tab displays unread info.

- Press [Edit] to select the info; press [Delete] to delete the selected info.
- Press [Clear] to delete all info after confirmation.

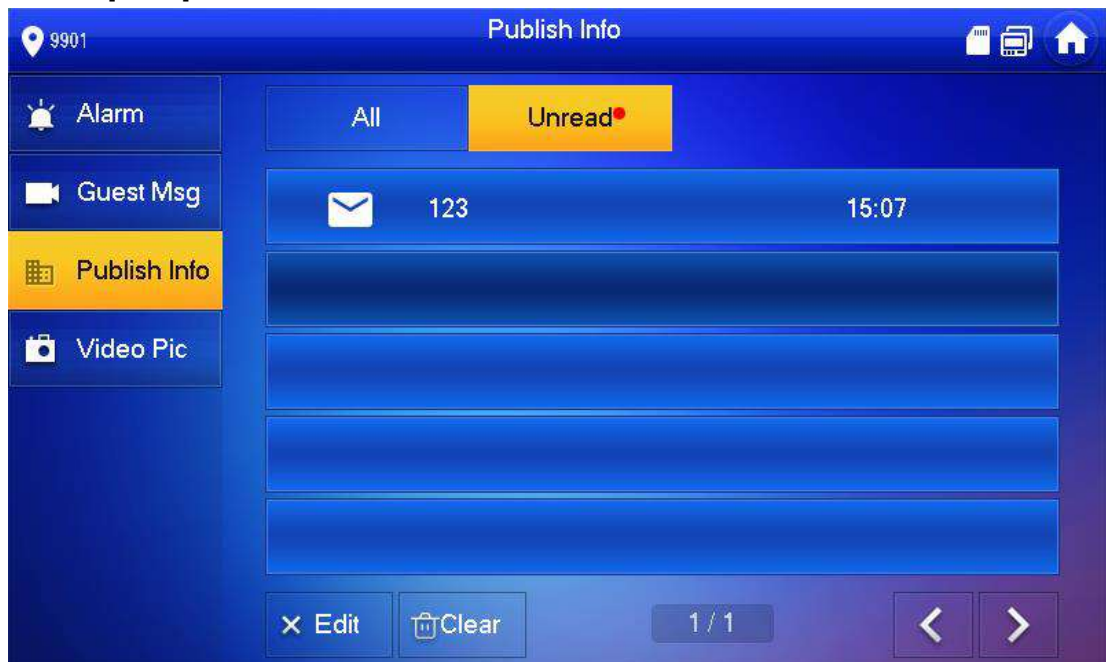

Figure 6-47

6.7.4 Video Pic



Caution

When a SD card is inserted into the device, this function is valid. All videos and pictures are stored in SD card.

Select “Info > Video Pic”, and the system displays “Video Pic” interface, as shown in Figure 6-48.

- Press [Edit] to select the video or picture; press [Delete] to delete the selected video or picture.
- Press [Clear] to delete all videos and pictures after confirmation.



Figure 6-48

6.8 Unlock Function

When the VTH is being called, during monitoring, talking and speaking, press exit button, and the VTO will be unlocked remotely.

6.9 Arm and Disarm Function

6.9.1 Arm

In case of triggering alarm after arm, produce linkage alarm and upload alarm info.



Caution

- Please ensure that the area has been added into arm mode. Otherwise, there will be no alarm triggering after arm.
- Please ensure that it is in disarmed status. Otherwise, arm will fail.



Step 1 Press  at the main interface.

The system displays arm mode, as shown in Figure 6-49.

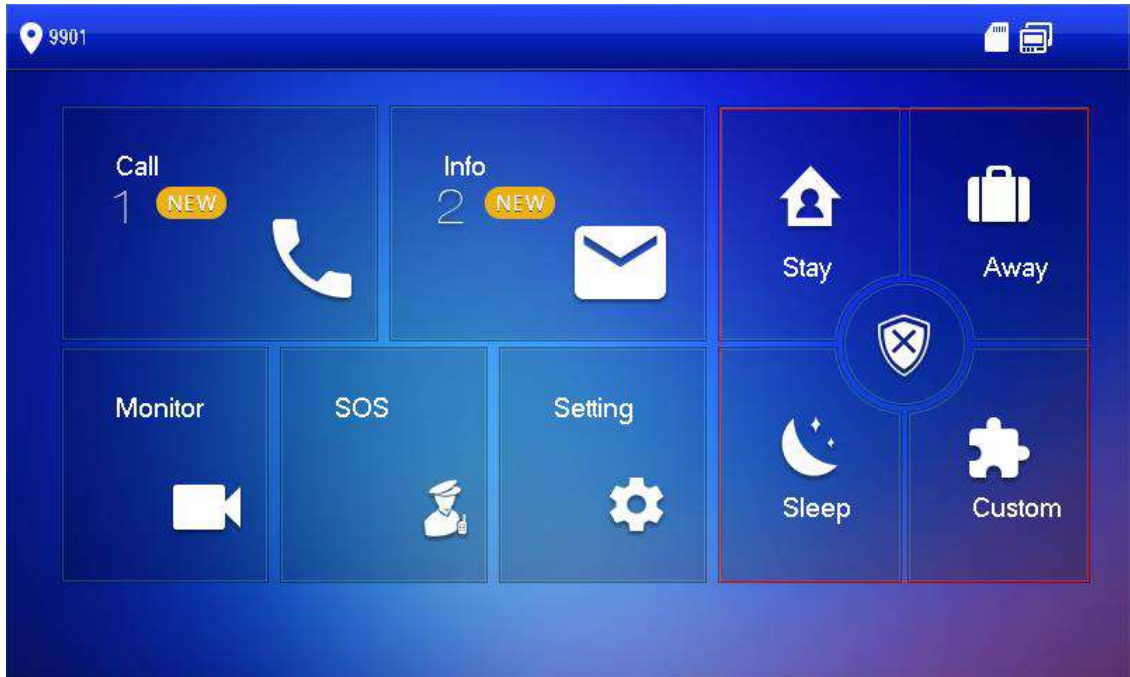

Figure 6-49

Step 2 Select arm mode.

The system displays password input interface.

Step 3 Enter arm and disarm password; press [OK].

The device beeps continuously, which represents successful arm. The key displays corresponding arm mode.



- Default password of arm and disarm is 123456. Please refer to “6.2.5.3 Password Setting” for details.
- If delay alarm is set in the area, the device will beep continuously at the end of exit delay time.

6.9.2 Disarm



Caution

Please ensure that it is in armed status. Otherwise, disarm will fail.

Step 1 Press disarm symbol at the lower right corner of the main interface.

The system displays password input interface.

Step 2 Enter arm and disarm password; press [OK].

The system displays successful disarm.



- Default password of arm and disarm is 123456. Please refer to “6.2.5.3 Password Setting” for details.
- If you are forced to enter disarm password in case of emergencies, enter anti-hijacking password, which is the reversed arm password. The system will disarm, and at the same time, upload alarm info to management center/platform.

Appendix 1 Technical Parameters

Appendix 1.1 VTH5221D Series /VTH5241D Series

Model		VTH5221D	VTH5241D
System	Main Processor	Embedded CPU	
	Operating System	Embedded LINUX Operating System	
Video	Display	7"HD LCD 1024x600	10"HD LCD 1024x600
	Camera (Type C)	1 megapixel CMOS HD camera	
Audio	Talk	Support two-way audio talk	
	Input	Omnidirectional microphone	
	Audio Enhancement	Echo suppression and digital noise reduction	
Operating Mode	Input	Capacitance touch and 5 shortcut keys	
	Alarm Input	8-channel	
	Alarm Output	1-channel	
Structure	Material	PC+ABS	
	Installation	Installation with 86 box in the wall	
Network	Ethernet	10M/100Mbps self-adaptive; Support WI-FI 802.11b/g/n	
	Network Protocol	TCP/IP	
Parameter	Power Supply	DC 12V-24V or designated switch	
	Power Consumption	Standby≤1W; working≤8W	
	Working Temperature	- 10℃~+55℃	
	Relative Humidity	10% RH~90%RH	
	Size (Length× Width × Height)	215mm×140mm×16mm	265mm×180mm×21mm

Appendix 1.2 VTH5222H Series

Model		VTH5222H
System	Main Processor	Embedded microcontroller
	Operating System	Embedded LINUX Operating System
Video	Video Compression Standard	H.264
	Video Resolution	800×480
	Front Camera	None
Audio	Input	Omnidirectional microphone
	Output	Built-in speaker
	Talk	Support two-way audio talk
Display	Screen Size	7"TFT color screen

Operating Mode	Input	Mechanical key (SOS, menu, call, monitor and unlock), touch screen technology
Alarm	Alarm Input	Support 6-channel alarm input
	Alarm Output	Support 1-channel alarm output (dry contact)
Network	Ethernet	10M/100Mbps self-adaptive
	Network Protocol	TCP/IP
	Wi-Fi	Not available
Parameter	Power Supply	Direct power supply from private exchange
	Power Consumption	Standby≤1.5W; working≤7W
	Working Environment	-10℃~+60℃
		10%RH~90%RH
	Size (Length× Width × Height)	200mm×136mm×22mm
Weight	0.8kg	

Appendix 1.3 VTH15 Series Type A/B/CH

Model		VTH15 Series Type A	VTH15 Series Type B(W)	VTH15 Series Type CH
System	Main Processor	Embedded microcontroller		
	Operating System	Embedded LINUX Operating System		
Video	Video Compression Standard	H.264		
	Video Resolution	800×480		
	Front Camera	Only VTH1520CH supports front Camera, 300,000 pixels		
Audio	Input	Omnidirectional microphone		
	Output	Built-in speaker		
	Talk	Support two-way audio talk		
Display	Screen Size	7" TFT color screen		
Operating Mode	Input	Mechanical key (SOS, menu, call, monitor and unlock), touch screen technology		
Alarm	Alarm Input	Support 8-channel local alarm input		
	Alarm Output	None		
Network	Ethernet	10M/100Mbps self-adaptive		
	Network Protocol	TCP/IP		
Parameter	Power Supply	DC10V – 15V or direct power supply from private exchange		
	Power	Standby≤1.5W; working≤7W		

	Consumption			
	Working Environment	-10°C~+60°C		
		10%RH~90%RH		
	Size (Length× Width × Height)	221mm×154mm×25m	221mm×154mm×25m	200mm×136mm×22m
	Weight	0.8kg		

Appendix 1.4 VTH16 Series

Model		VTH1660CH
System	Main Processor	Embedded microcontroller
	Operating System	Embedded LINUX Operating System
Video	Video Compression Standard	H.264
	Video Resolution	800×480
	Front Camera	None
Audio	Input	Omnidirectional microphone
	Output	Built-in speaker
	Talk	Support two-way audio talk
Display	Screen Size	10.2" TFT color screen
Operating Mode	Input	Touch screen technology
Alarm	Alarm Input	6-channel
	Alarm Output	1-channel
Network	Ethernet	10M/100Mbps self-adaptive
	Network Protocol	TCP/IP
Parameter	Power Supply	DC10V – 15V or direct power supply from private exchange
	Power Consumption	Standby≤1.5W; working≤7W
	Working Environment	-10°C~+60°C
		10%RH~90%RH
	Size (Length× Width × Height)	260mm×189mm×22.7mm
Weight	0.8Kg	

Appendix 1.5 VTH2221A Series

Model		VTH2221A
System	Main Processor	Embedded microcontroller
	Operating System	Embedded LINUX Operating System

Model		VTH2221A	
Video	Video Compression Standard	H.264	
	Video Resolution	800×480	
	Front Camera	None	
Audio	Input	Omnidirectional microphone	
	Output	Built-in speaker	
	Talk	Support two-way audio talk	
Display	Screen Size	7" TFT color screen	
Operating Mode	Input	Mechanical key (SOS, menu, call, monitor and unlock), touch screen technology	
Alarm	Alarm Input	Support 8-channel local alarm input	
	Alarm Output	Reserve 1-channel local alarm output	
Network	Ethernet	10M/100Mbps self-adaptive	
	Network Protocol	TCP/IP	
Parameter	Power Supply	DC10V – 15V or direct power supply from private exchange	
	Power Consumption	Standby≤1.5W; working≤7W	
	Working Environment		-10℃~+55℃
			10%RH~90%RH
	Size (Length×Width × Height)		220mm×153mm×22.5mm
	Weight		0.8kg