

# **2-Wire VTH1550CHW-2 User's Manual**

V1.0.0

# Table of Contents

1	General Introduction .....	4
1.1	Network .....	4
1.2	Front Panel.....	5
1.3	Rear Panel.....	6
2	Installation.....	7
2.1	Install Device.....	7
2.1.1	Screw.....	7
2.1.2	Steps.....	7
2.2	Cable Connection.....	8
2.3	Basic Config.....	8
2.3.1	Config .....	8
2.3.2	Result Verification.....	11
3	Product Function .....	12
3.1	Basic Function .....	12
3.1.1	Main Menu.....	12
3.1.2	Video Talk.....	13
3.1.3	Security .....	14
3.1.4	Info Search .....	16
3.1.5	System Settings.....	17
3.2	Unlock .....	21
3.3	Arm/Disarm .....	21
3.4	2.4 Screen Calibration.....	22
	Appendix 1 Technical Specification.....	23
	Appendix 2 Toxic or Hazardous Materials or Elements .....	24

## Important Safeguards and Warnings

Please read the following safeguards and warnings carefully before using the product in order to avoid damages and losses.

Note:

- Do not expose the device to lampblack, steam or dust. Otherwise it may cause fire or electric shock.
- Do not install the device at position exposed to sunlight or in high temperature. Temperature rise in device may cause fire.
- Do not expose the device to humid environment. Otherwise it may cause fire.
- The device must be installed on solid and flat surface in order to guarantee safety under load and earthquake. Otherwise, it may cause device to fall off or turnover.
- Do not place the device on carpet or quilt.
- Do not block air vent of the device or ventilation around the device. Otherwise, temperature in device will rise and may cause fire.
- Do not place any object on the device.
- Do not disassemble the device without professional instruction.

Warning:

- Please use battery properly to avoid fire, explosion and other dangers.
- Please replace used battery with battery of the same type.
- Do not use power line other than the one specified. Please use it properly. Otherwise, it may cause fire or electric shock.

## Special Announcement

- This manual is for reference only.
- All the designs and software here are subject to change without prior written notice.
- All trademarks and registered trademarks are the properties of their respective owners.
- If there is any uncertainty or controversy, please refer to the final explanation of us.
- Please visit our website for more information.

# 1 General Introduction

## 1.1 Network

Here introduces application of VTH, and please read the following contents before installation. See Figure 1- 1 Villa Networking 1 and Figure 1- 2 Villa Networking 2.

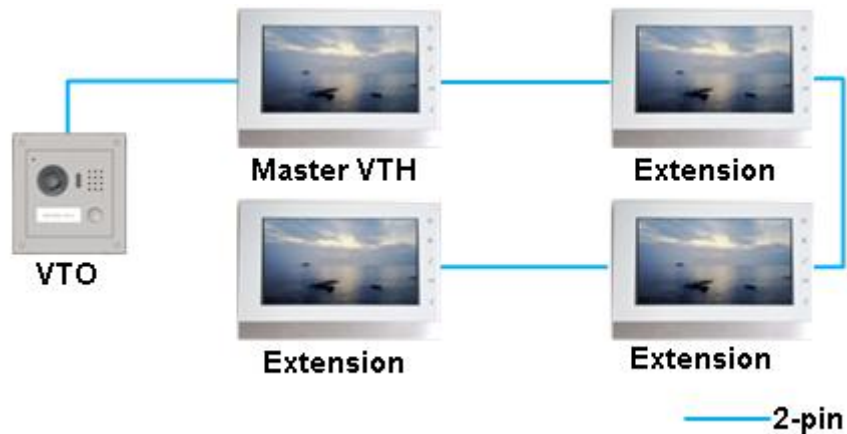

Figure 1- 1 Villa Networking 1

1 VTO and 4 VTH (maximum) are connected via 2-pin cable for networking. When visitor calls the resident via VTO, resident may unlock door from any one master VTH or extension.

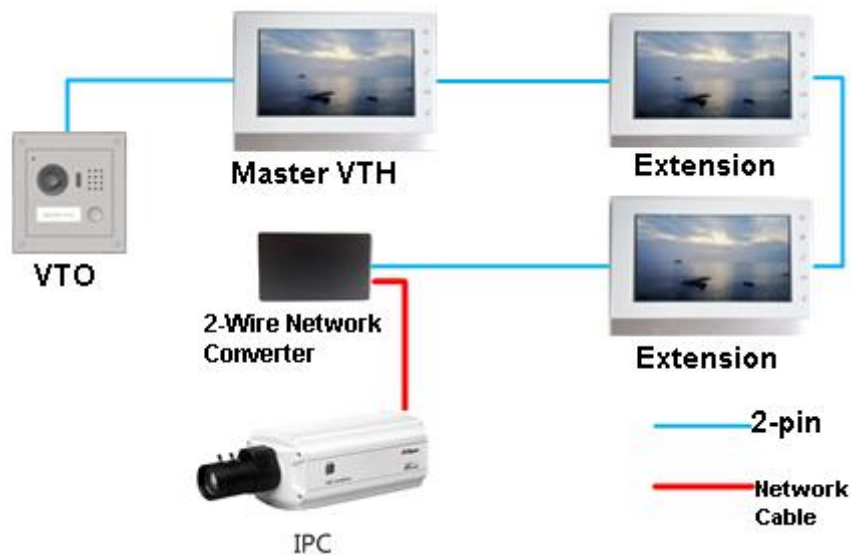

Figure 1- 2 Villa Networking 2

1 VTO, 3 VTH (maximum), analog converter are connected via 2-pin cable. On analog converter, use network cable to connect IPC for networking. When visitor calls the resident via VTO, resident may unlock door from any one master VTH or extension. Resident can view IPC video on VTH.

## 1.2 Front Panel

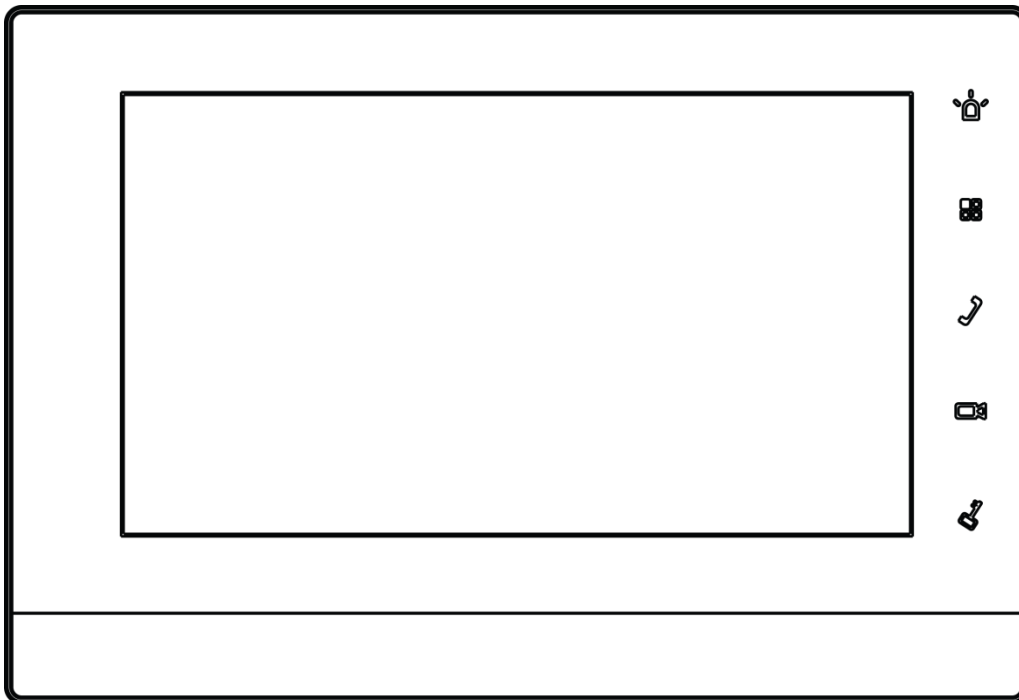







Figure 1- 3

Name	Note
	Emergent call to center.
	Press this button to return to main menu.
	Under calling, status, press this button to answer call. During a call, press this button to hang up.
	Monitor VTO video.
	During incoming call, calling, monitoring status, press this button to unlock.

### 1.3 Rear Panel

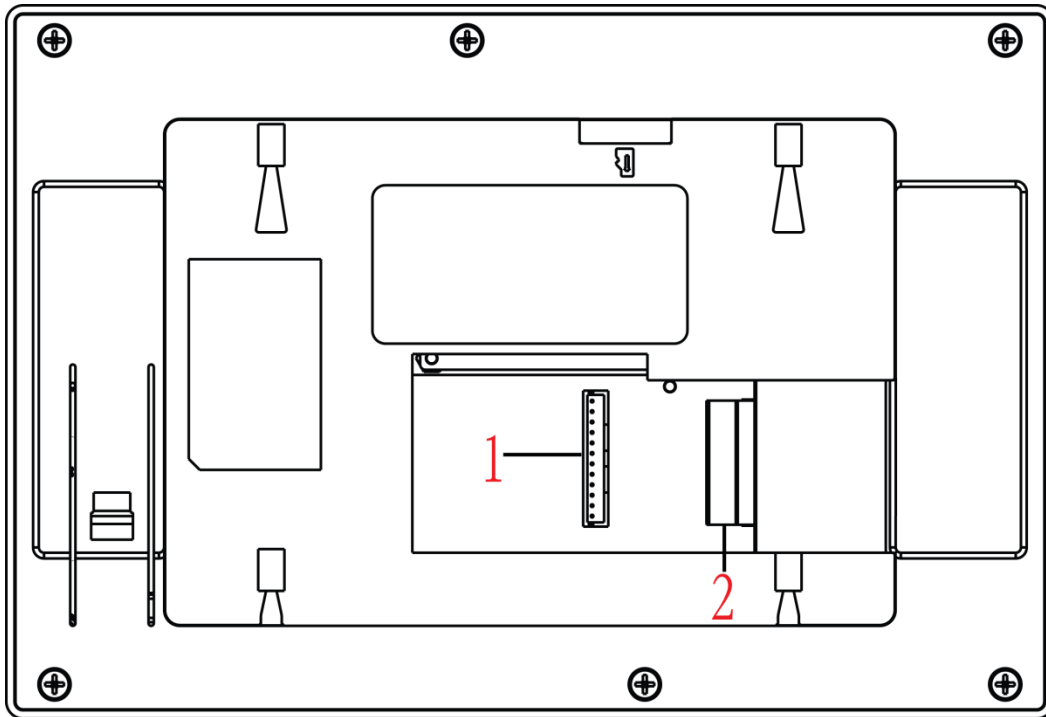

Figure 1- 4

No.	Name	Note
1	Alarm port	6-ch alarm in and 1-ch alarm out, refer to label for details.
2	2-Wire port	3 groups of 2-wire ports, may connect to power, VTH, VTO or converter module.

# 2 Installation

## 2.1 Install Device

This device support direct installation, as not digging exit hole of wiring on wall and all wirings come out from side.

**Warning:**

- Avoid installation in poor environment, such as condensation, high temperature, oil stain, dust, corrosion or direct sunlight.
- After device is plugged to power, if you find any abnormal phenomenon, you shall immediately unplug network cable and cut power supply. You may re-plug in power after troubleshooting.
- Project installation and debugging must be done by professionals. Please do not open the device in case of failure, and please contact after sales service.

### 2.1.1 Screw

Component Name	Diagram	Quantity
ST3x18 cross pan head tail self-tapping screw-nickel plating white		3

Chart 2- 1

### 2.1.2 Steps

Step 1. Fix installation bracket on wall, with screw (STS x 18 cross pan head tail self-tapping screw).

Step 2. Fix device on installation bracket and buckle it. See Figure 2- 1.

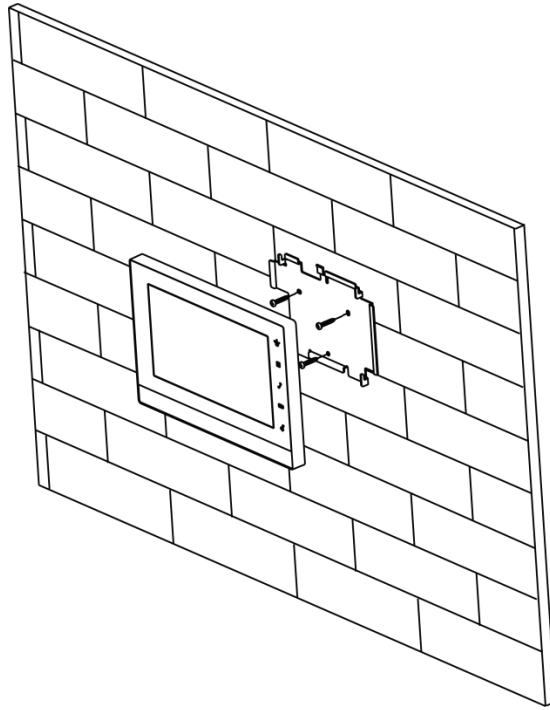

Figure 2- 1

## 2.2 Cable Connection

Please see Ch 1.3.

## 2.3 Basic Config

After config, it will have talk function.

### 2.3.1 Config

Step 1. In Project Settings interface, select System Settings>Project Settings and enter password (002236) to enter Project Settings interface. See Figure 2- 2.



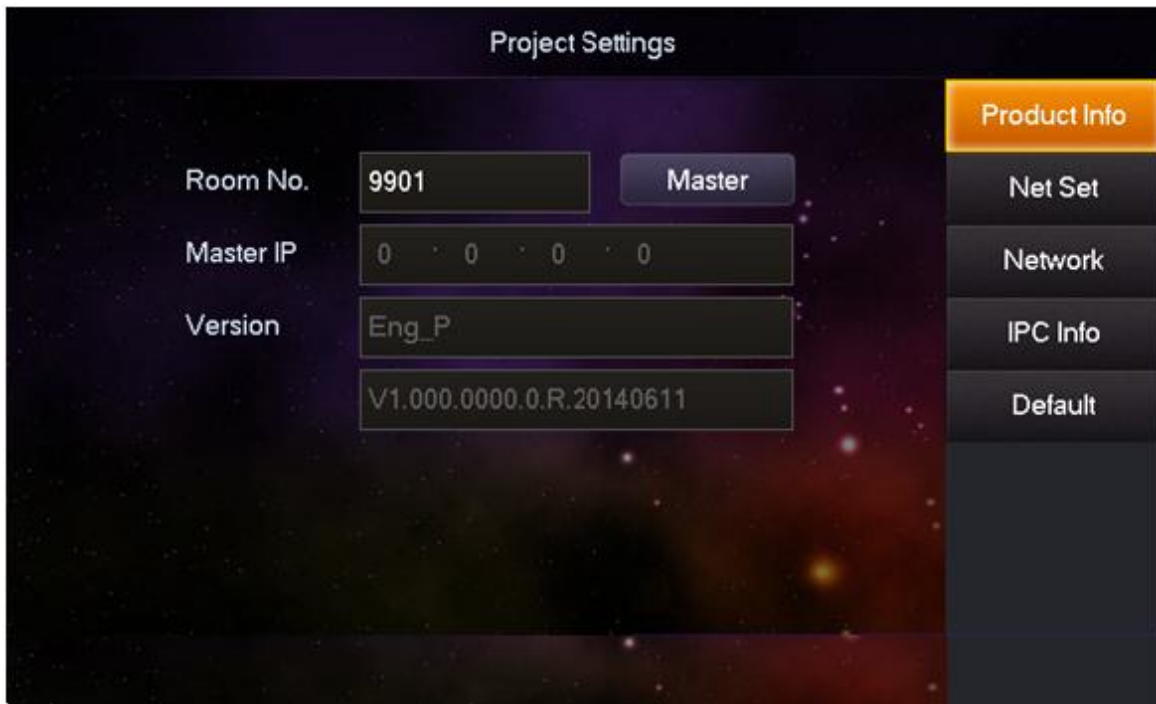

Figure 2- 2 Local

Step 2. If the VTH is master VTH, then select Master, and fill in room no.

Step 3. If the VTH is extension VTH, then select extension and fill no. In host IP, fill in IP of master VTH, so extension VTH will be automatically sync with host user config. See Figure 2- 3 Local (extension). Click OK.

Note:

VTH room no. must match setup of VTH short no. in WEB of VTO.



Figure 2- 3 Local (extension)

Step 4. Fill in master VTO name, master VTO IP, and set enable status to ON. See Figure 2- 4.

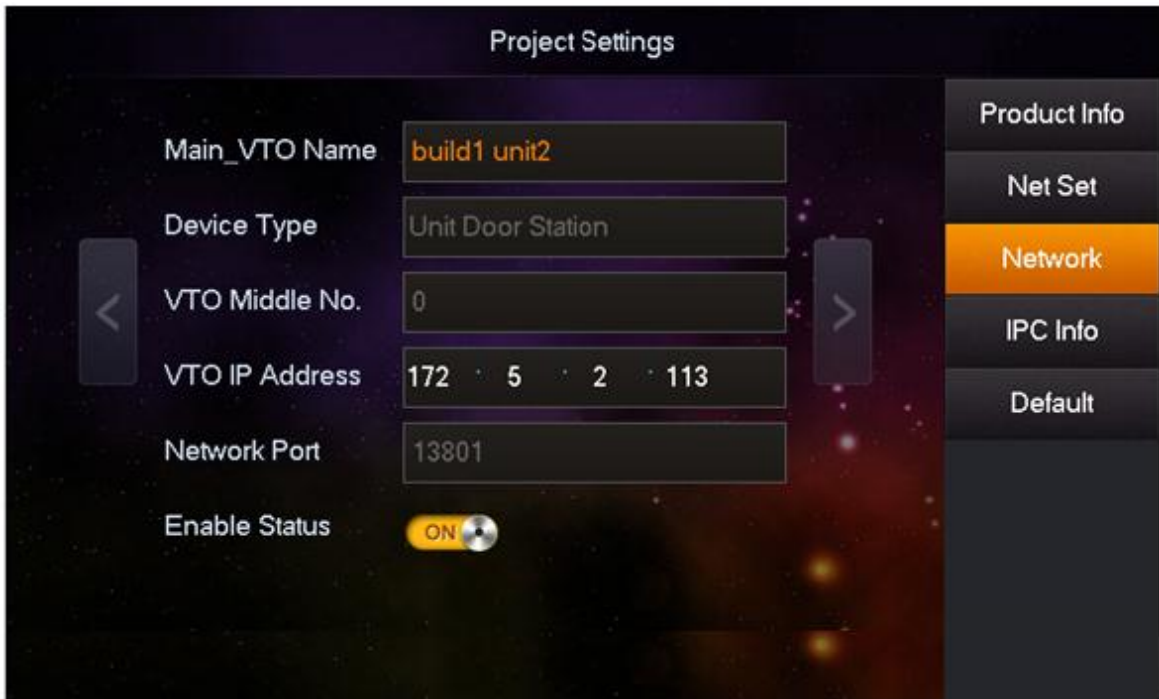



Figure 2- 4

Step 5. Press , and press Call button to go down. Fill in extension VTO name, extension VTO IP address. Set enable status to ON. You can add more than one extension VTO. See Figure 2- 5.

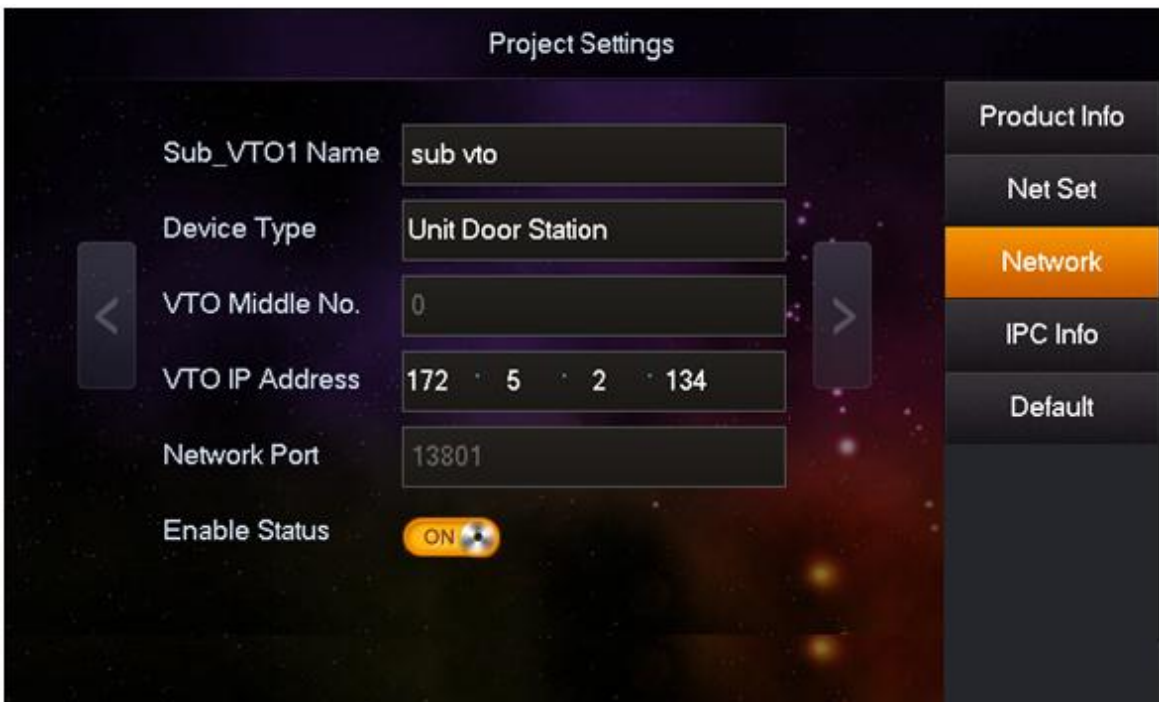

Figure 2- 5

Step 6. Click OK.

### **2.3.2 Result Verification**

VTO call VTH via room no. VTH pops up monitoring video and operation buttons. You can accept, hand up or unlock via VTH.

# 3 Product Function





## 3.1 Basic Function

### 3.1.1 Main Menu

Main menu includes four options, as Video Talk, Security, Message, and Settings.



Figure 3- 1



Icon	Name	Note
	Network connection icon	It means network connection is normal.
	VTO not connected	It means device does not connect to any VTO.
	DND icon	It means device enable DND (do not disturb) function.
	Missed icon	It means user has missed message.

### 3.1.2 Video Talk

In main menu, click Video Talk to enter Video Talk interface.

#### 3.1.2.1 Call User

This function is used for VTH to call VTH.

Step 1. Click  , Input room no. of user to call (i.e. Building 1, Unit 1, Room 101 is 1-1-101), press  icon to call. When the user being called answers the call, user can have a bidirectional talk. See Figure 3- 2.

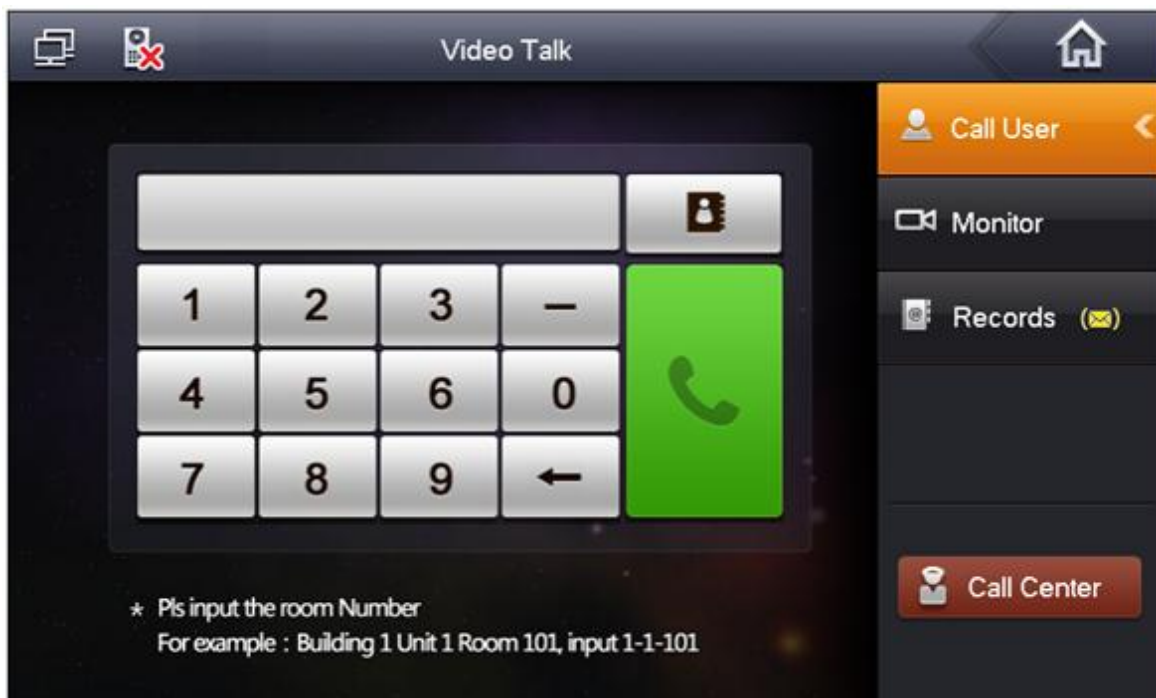



Figure 3- 2

Step 2. Click  contact book icon, user can call, add, edit and delete contacts.

Note:

If both the two indoor door stations are VTH-CH models (with front camera), then you can perform a bidirectional visual talk.

#### 3.1.2.2 Monitor

Click  , you can monitor unit VTO, fence station or IPC.

### 3.1.2.3 2.1.2.3 Call History

Click  **Records**, you can view missed call, answered call and called call. See Figure 3- 3.

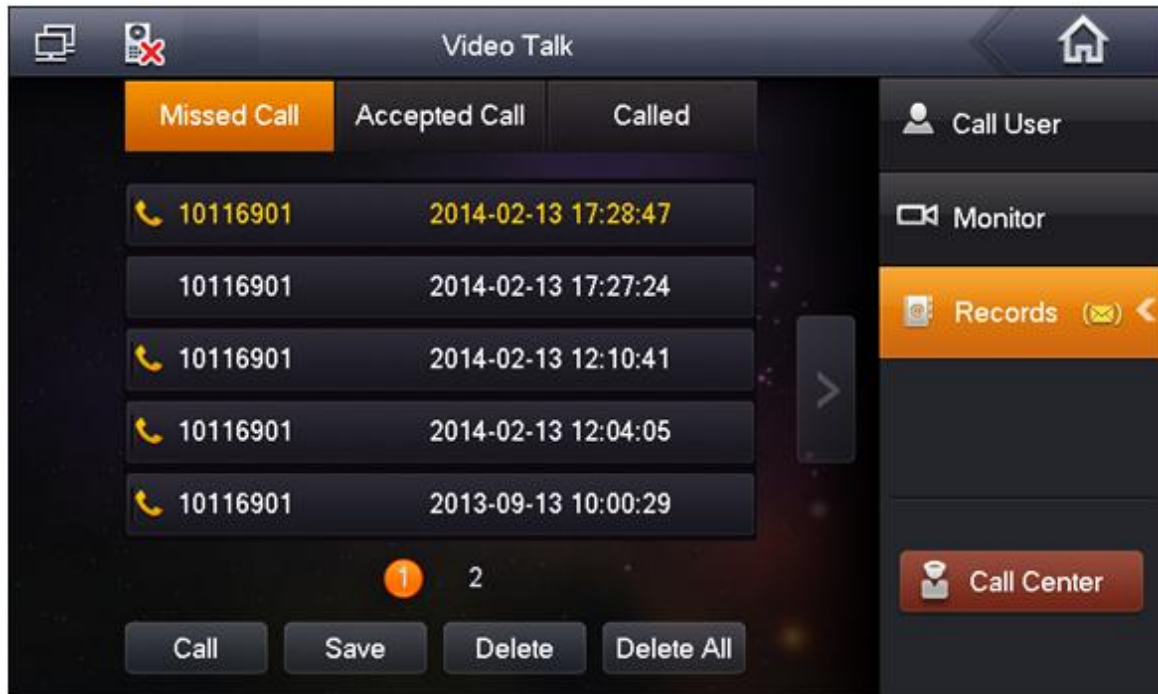



Figure 3- 3

### 3.1.2.4 Management Center

Click  **Call Center** or press Emergency button, and it is to call MGT center.

## 3.1.3 Security

In main menu, click Security to enter Security interface.

### 3.1.3.1 Armed zone

Step 1. Click  **Area Status**, interface shows current 8-ch area status, including Area Type, Current Status, and Delay Time. See Figure 3- 4.

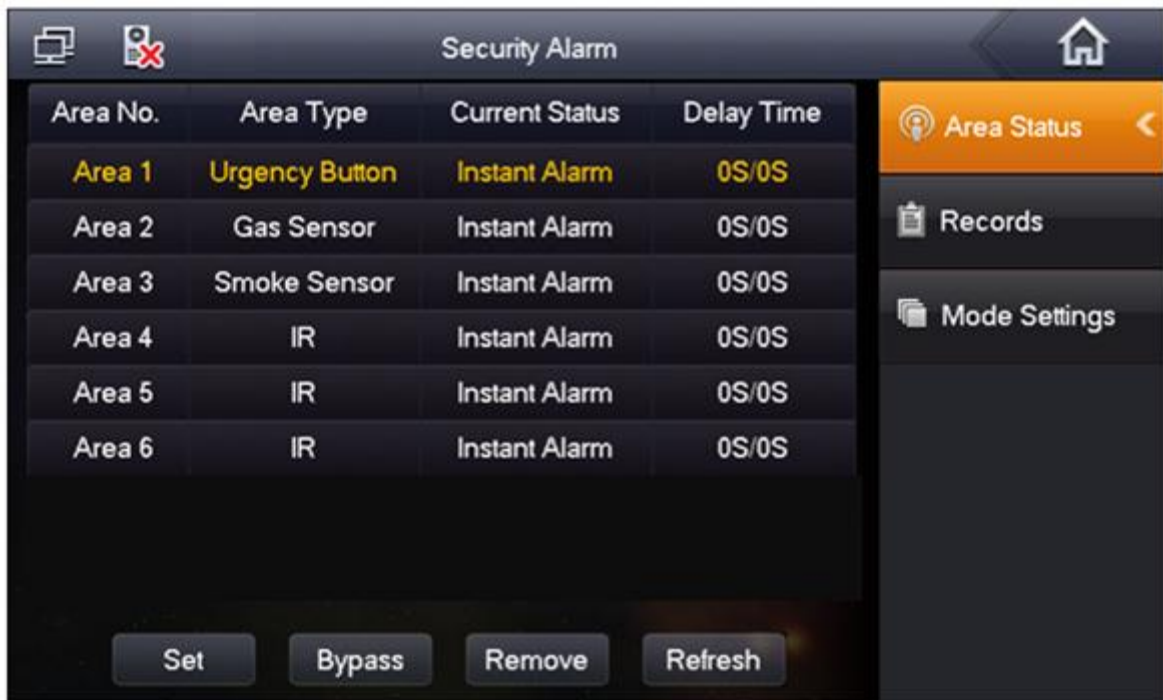

Figure 3- 4

Step 2. Click Set, input password, to enter area setting interface. See Figure 3- 5.

Note:

The entry password is user password. Default password is 123456, please see Ch 3.1.6.

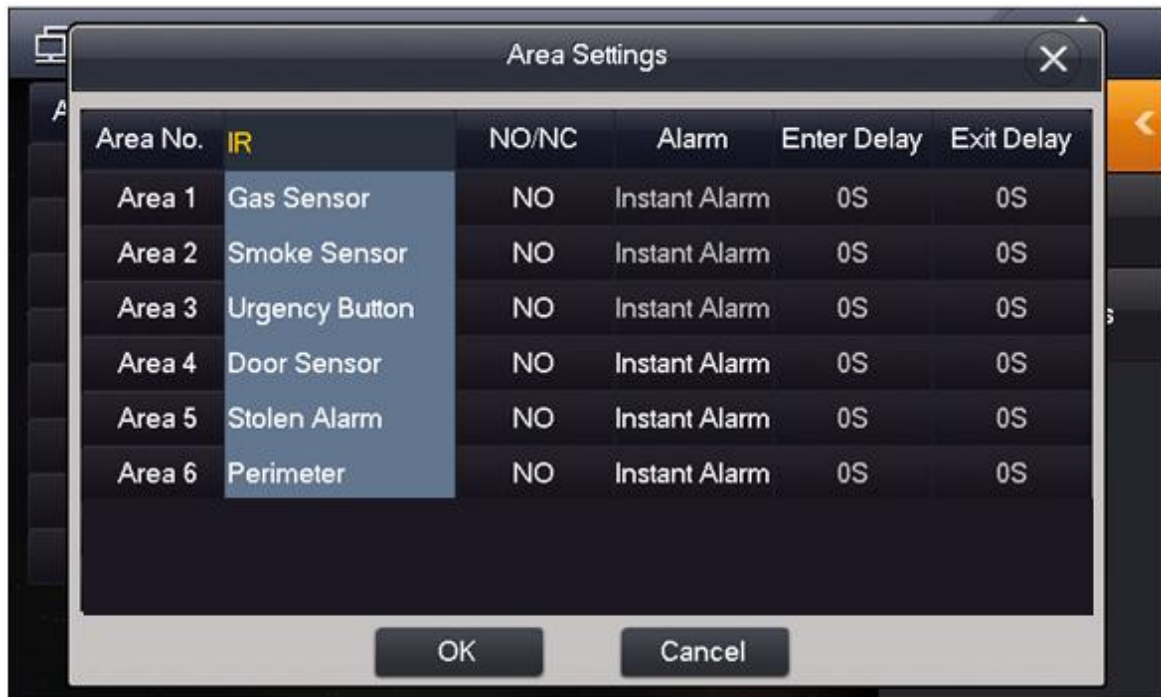

Figure 3- 5

You can set bypass and delete for 4~6 channels to disable area for one time or long-term.

### 3.1.3.2 Alarm History

Click  **Records**, and it records alarm time, area no., and event.

Meantime, alarm info will be simultaneously uploaded to management platform. When each channel has alarm, there will be a 15s alarm locally, plus a pop-up alarm interface.

### 3.1.3.3 Mode Setup

Click  **Mode Settings**, set area alarm mode, including Out mode, In mode, Sleep mode and Custom mode. See Figure 3- 6.

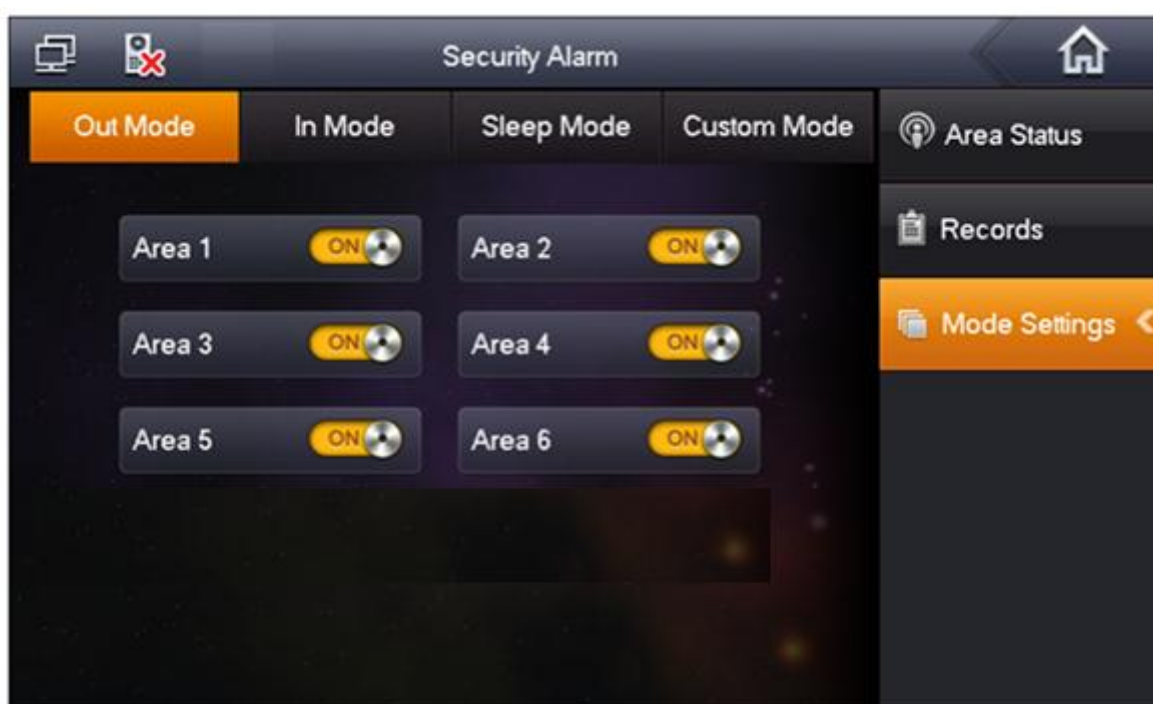



Figure 3- 6

Note:

Password to enter mode setup page is the user password, and default password is 123456. Refer to Ch 3.1.6.

### 3.1.4 Info Search

In main menu, click Info Search, to enter Info Search interface.

Click  **Publish Info**, you can view, delete and clear information published.

VTH receives information from the center, and indicator will turn on. See Figure 3- 7.



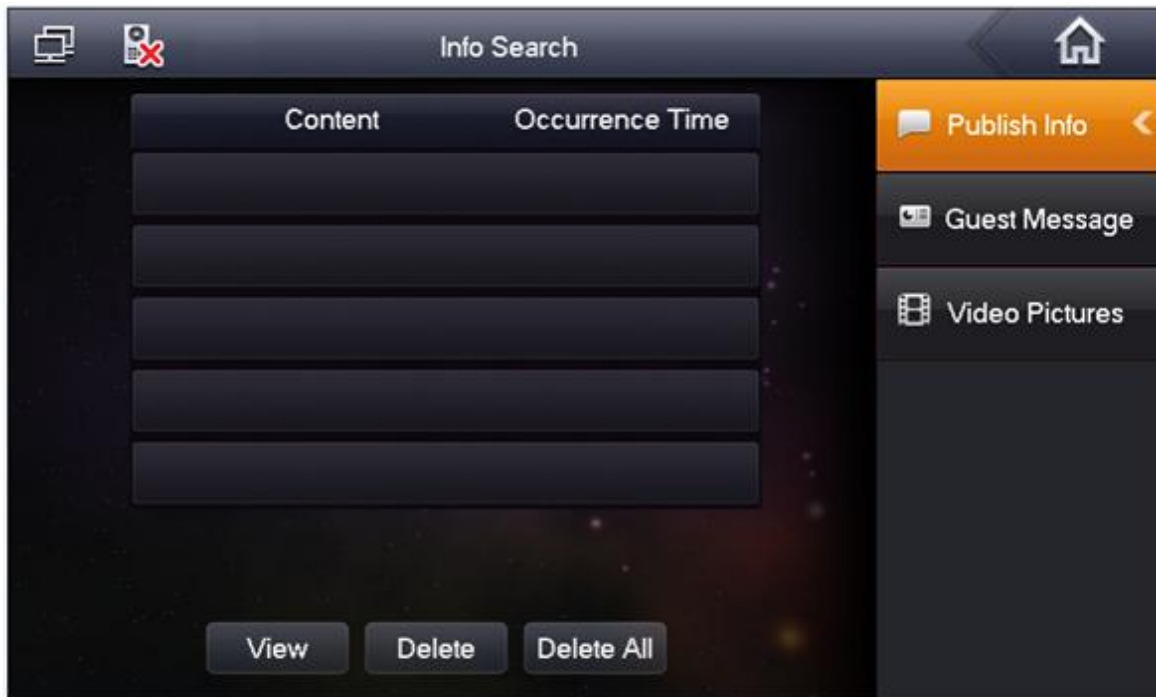



Figure 3- 7

### 3.1.5 System Settings

In main interface, click System Settings to enter system settings interface. You can set VTH screen brightness, incoming call ring, talk time, DND (do not disturb) time and etc.

#### 3.1.5.1 User Settings

Click on  **User Settings**, you can set password, ring, talk, DND, local IPC, clean, touch ring, SD card and snapshot plus restore default settings. See Figure 3- 8.

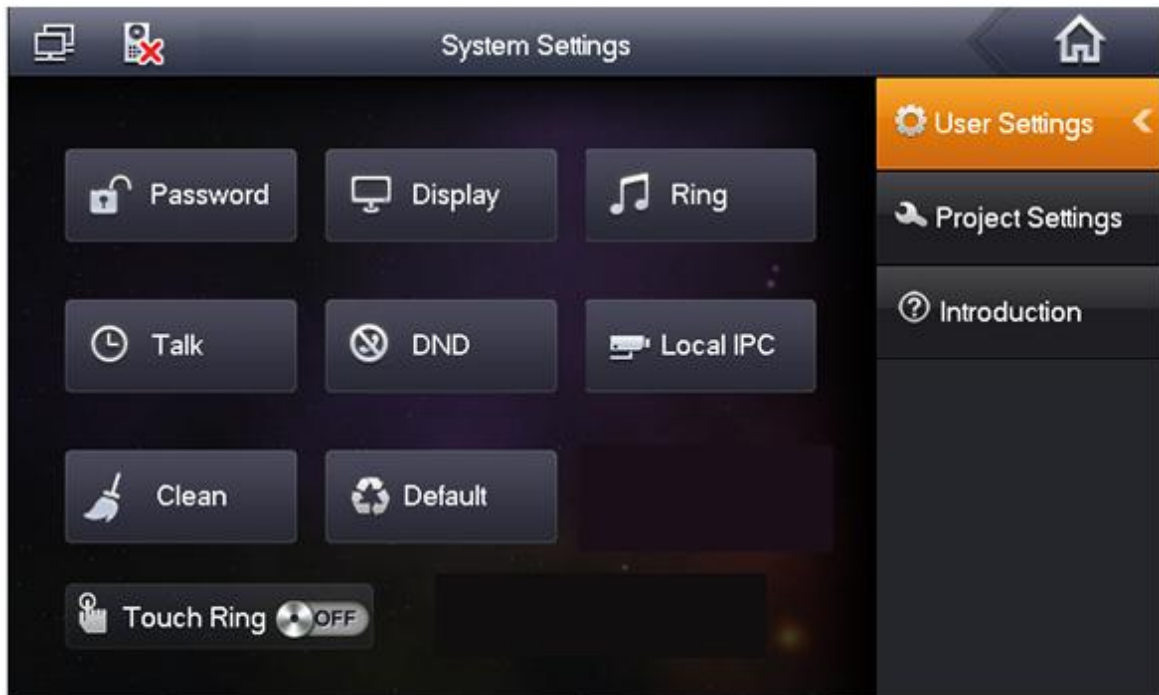

Figure 3- 8

### Password

Step 1. Click on Password. You can set user password, unlock password, arm password and anti-hijack password. See Figure 3- 9.

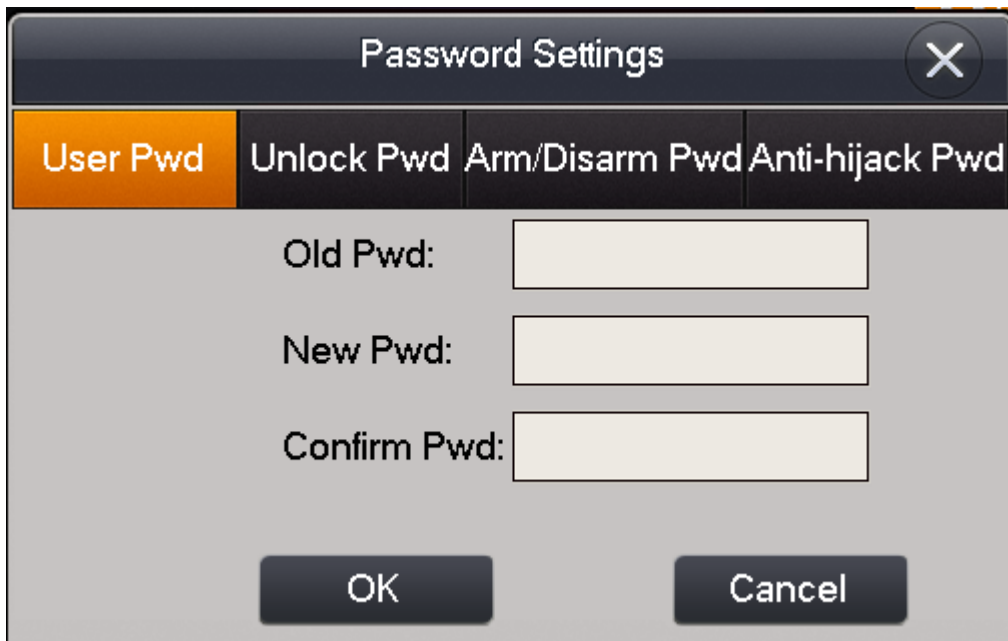

Figure 3- 9

- User password initially is 123456.
- Unlock password initially is null.
- Arm password initially is 123456.
- Disarm password initially is 123456.
- Anti-hijack password initially is 654321.

Note:

Some series has the same password for arming and disarming.

Step 2. Click on OK when you complete.

### Display

Click on Display. You can set screen brightness and screensaver via **+** and **-**.

### Ring

Click on Ring. You can set call ring and alarm ring via **+** and **-**.

### Talk

Step 1. Click on Talk. You can set ring, call time, monitor time, record time and message time of VTO and VTH. See Figure 3- 10.



Figure 3- 10

Step 2. Click on **+** to increase time, click on **-** to decrease time. Unit is second.

Step 3. Click on OK.

### DND

Click on DND to set do not disturb time. Unit is hour.

### Local IPC

Step 1. Click on Local IPC. You can set IPC name, address, username and password. See Figure 3- 11.



The screenshot shows a window titled "Local IPC" with a close button in the top right corner. The window contains the following fields and controls:

- IPC1 Name:** An empty text input field.
- IP Address:** A text input field containing "0 . 0 . 0 . 0".
- User Name:** A text input field containing "admin".
- Password:** A text input field with six dots representing a masked password.
- Save:** A dark button with the text "Save" in white.
- Navigation:** A vertical button with a right-pointing arrow is located on the right side of the form.

Figure 3- 11

Step 2. Click on Save.

Step 3. In homepage, click on talk to view added IPC video.

### Clean

Click on Clean to lock screen and now you can clean the screen.

### Default

Click on Default to restore system default settings.

### Touch Ring

Slide . ON means touch sound is on. OFF means touch sound is off.

### 3.1.5.2 Project Settings

Click on  **Project Settings**, this function is for installer user only. The entry password is 002236.

### 3.1.5.3 Introduction

Click on , you can view this product and problems might encounter during usage.

## 3.2 Unlock

When VTH is being called, monitored, in call status, press unlock button or unlock icon on VTH to remotely unlock door.

## 3.3 Arm/Disarm

### Disarm Status

Press arm icon in homepage, select one mode (out, in, sleep and custom). In pop-up box, input arm password (default password is 123456.). See Figure 3- 12.

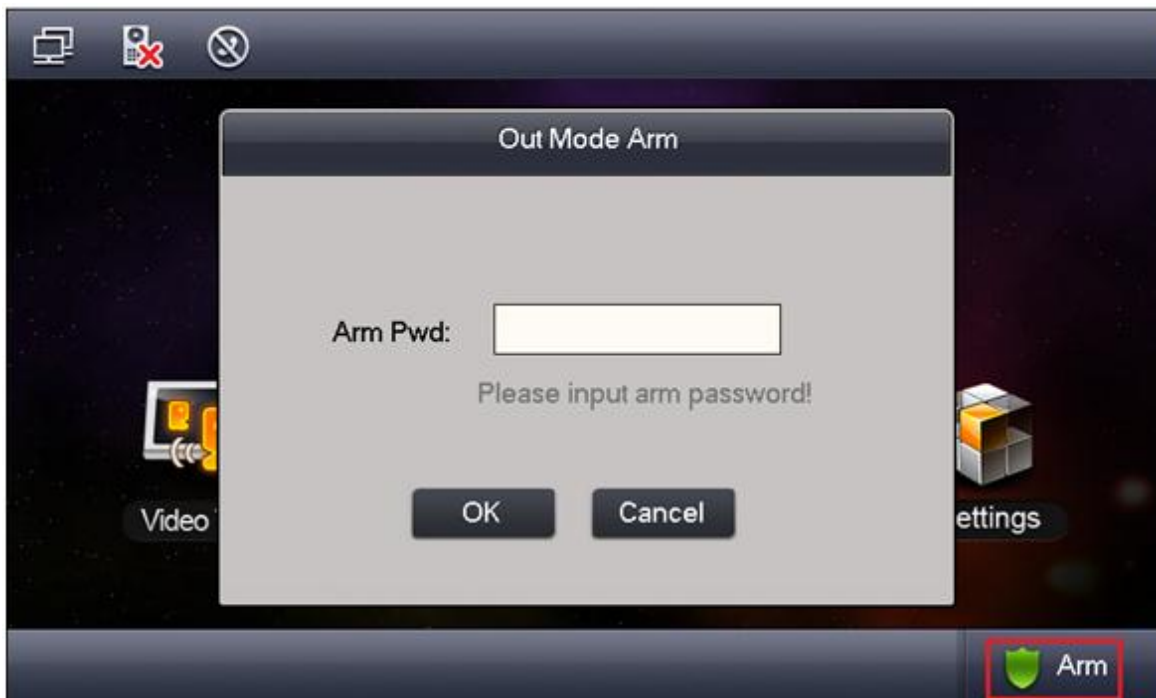

Figure 3- 12

- If you select delay, then system will enter armed status after the delay period.
- If you select immediate arm, then system will enter armed status when audio prompt ends.

### Arm Status

Press disarm icon in the lower right corner of main menu. Input disarm password (default

password is 123456.). If the password is correct, system will say disarmed successfully. If the password is incorrect, system will ask you to try again.

Note:

About how to modify arm/disarm password, please refer to Ch 3.1.6.

### **3.4.2.4 Screen Calibration**

The product is calibrated before shipped out from factory, and if you want to calibrate the screen, press unlock+arm/menu button to enter calibration interface. Calibrate the screen according to the tips.

# Appendix 1 Technical Specification

<b>Model</b>	VTH1550CHW-2	
<b>System</b>		
Main Processor	Built-in microcontroller	
Operating System	Built-in LINUX system	
<b>Video</b>		
Video Compression Standard	H.264	
Video Resolution	800×480	
<b>Audio</b>		
Input	All-direction microphone	
Output	Built-in loudspeaker	
Bidirectional Talk	Support bidirectional talk	
<b>Display</b>		
Screen Dimension	7 inch TFT full real color	
<b>Operation Mode</b>		
Input	Touch screen	
<b>Alarm</b>		
Alarm Input	Support 6-ch local alarm inputs	
Alarm Output	Support 1-ch local alarm output	
<b>Network</b>		
Ethernet	10M/100Mbps self-adaptive	
Network Protocol	TCP/IP	
<b>Specifications</b>		
Power	DC 24V	
Consumption	Standby≤1W; working≤7W	
Working Environment	-10℃~+55℃	
	10%~90%RH	
Dimension (L×W×H)	200.5mm×136.5mm×22.0mm	
Weight	0.8kg	

# Appendix 2 Toxic or Hazardous Materials or Elements

Component Name	Toxic or Hazardous Materials or Elements					
	Pb	Hg	Cd	Cr VI	PBB	PBDE
Circuit Board Component	○	○	○	○	○	○
Device Case	○	○	○	○	○	○
Wire and Cable	○	○	○	○	○	○
Packing Components	○	○	○	○	○	○
Accessories	○	○	○	○	○	○

O: Indicates that the concentration of the hazardous substance in all homogeneous materials in the parts is below the relevant threshold of the SJ/T11363-2006 standard.

X: Indicates that the concentration of the hazardous substance of at least one of all homogeneous materials in the parts is above the relevant threshold of the SJ/T11363-2006 standard. During the environmental-friendly use period (EFUP) period, the toxic or hazardous substance or elements contained in products will not leak or mutate so that the use of these (substances or elements) will not result in any severe environmental pollution, any bodily injury or damage to any assets. The consumer is not authorized to process such kind of substances or elements, please return to the corresponding local authorities to process according to your local government statutes.

**Note:**

- **This manual is for reference only. Slight difference may be found in user interface.**
- **All the designs and software here are subject to change without prior written notice.**
- **All trademarks and registered trademarks are the properties of their respective owners.**
- **If there is any uncertainty or controversy, please refer to the final explanation of us.**
- **Please visit our website or contact userr local service engineer for more information.**