

# **Network Video Decoder Quick Start Guide**

**V3.4.0**

# Table of Contents

<b>1</b>	<b>FRONT PANEL/REAR PANEL/INSTALLATION .....</b>	<b>1</b>
1.1	Check Unpacked Device .....	1
1.2	Front panel .....	1
1.2.1	1/4-channel 4K High Definition & 1/4-channel High Definition Series .....	1
1.2.2	9-channel 4K high definition (with 4 input ports) series / 9-channel 4K high definition series / 9-channel High Definition Series / 16-channel High Definition Series .....	2
1.2.3	12-channel 4K high definition series / 12-channel 4K high definition (with 4 input ports) series / 15-channel 4K high definition series / 15-channel 4K high definition (with 4 input ports) series / 18-channel 4K high definition series / 18-channel 4K high definition (with 4 input ports) series / 21-channel 4K high definition series / 21-channel 4K high definition (with 4 input ports) series .....	3
1.3	Rear Panel .....	4
1.3.1	1-channel 4K High Definition Series .....	4
1.3.2	4-channel 4K high definition series .....	5
1.3.3	9-channel 4K high definition (with 4 input ports) series .....	5
1.3.4	9-channel 4K high definition series .....	6
1.3.5	1-channel High Definition Series .....	7
1.3.6	4-channel High Definition Series .....	7
1.3.7	9-channel High Definition Series .....	8
1.3.8	16-channel High Definition Series .....	8
1.3.9	12-channel 4K high definition series / 12-channel 4K high definition (with 4 input ports) series / 15-channel 4K high definition series / 15-channel 4K high definition (with 4 input ports) series / 18-channel 4K high definition series / 18-channel 4K high definition (with 4 input ports) series / 21-channel 4K high definition series / 21-channel 4K high definition (with 4 input ports) series .....	9
1.4	Connection .....	12
<b>2</b>	<b>OPERATION .....</b>	<b>13</b>
2.1	Boot Up and Shut Down .....	13

<b>2.2</b>	<b>Login.....</b>	<b>13</b>
2.2.1	Preparation .....	13
2.2.2	Login .....	14
<b>2.3</b>	<b>Main Window.....</b>	<b>16</b>

## **Welcome**

Thank you for purchasing our product!

This quick start guide will help you become familiar with our device in a very short time.

Before installation and operation please read the following safeguard and warning carefully!

Please keep it well for future reference !

# Important Safeguard and Warning

## 1 . Electrical safety

- All installation and operation here should conform to your local electrical safety codes.
- The product must be grounded to reduce the risk of electric shock.
- We assume no liability or responsibility for all the fires or electrical shock caused by improper handling or installation.
- Please use three-pin power socket (with GND).
- This device is to be connected only to the unit whose power feeding meets the requirements for SELV (Safety Extra Low Voltage) and complies with Limited Power Source according to IEC 60950-1.
- We are not liable for any problems caused by unauthorized modifications or attempted repair.

## 2 . Installation

- Do not apply power to the device before completing installation.
- Do not put object on the device.
- All the examination and repair work should be done by the qualified service engineers.

## 3 . Environment

- This series device should be installed in a cool, dry place away from direct sunlight, inflammable, explosive substances and etc.
- Please guarantee sound ventilation and keep device clean.

## 4. Accessories

- Be sure to use all the accessories recommended by manufacturer.
- Before installation, please open the package and check all the components are included.
- Contact your local retailer ASAP if something is broken in your package.

**RISK OF EXPLOSION IF BATTERY IS REPLACED BY AN INCORRECT TYPE.  
DISPOSE OF USED BATTERIES ACCORDING TO THE INSTRUCTIONS.**

# 1 Front Panel/Rear Panel/Installation

## Note:

- All the installation and operations here should conform to your local electric safety rules.
- VGA cable quality and length can affect the video quality. It may result in distorted video, noise, black margin. The video quality may vary even if you are viewing the same video via different VGA cables.

## 1.1 Check Unpacked Device

When you received the device from the shipping agency, please check whether there is any visible damage. The protective materials used for the package of the device can protect most accidental clashes during transportation. Then you can open the box to check the accessories.

Please check the items in accordance with the list.

Finally you can remove the protective film of the device.

The label at the bottom of the box is very important. Usually we need you to present the serial number when we provide the service after sales.

## 1.2 Front panel





### 1.2.1 1/4-channel 4K High Definition & 1/4-channel High Definition Series





The 1-channel 4K high definition and 1/4-channel high definition series front panel is shown as in Figure 1-1.



Figure 1-1

Please refer to the following sheet for detailed information.

Name	Icon	Function
Power button		Press it for three seconds to boot up or shut down the device. Press it three times within one second, it can clear device configuration.
Power indicator light		The indicator light becomes on when system boots up.
Network indicator light		The indicator light becomes on when abnormal network event occurs (offline, IP conflict and etc.)
USB port		Connect to external USB device.

Name	Icon	Function
Alarm indicator light		The light becomes on when there is an alarm.
HDD indicator light		N/A
IR receiver		N/A
Output indicator light		It is to display output port working mode. For 1-channel 4K high definition series and 1-channel high definition series, only the first indicator light is effective. For 4-channel 4K high definition series and 4-channel high definition series, only the channel 1 to channel 4 indicator lights is effective.

### 1.2.2 9-channel 4K high definition (with 4 input ports) series / 9-channel 4K high definition series / 9-channel High Definition Series / 16-channel High Definition Series

The 9-channel 4K high definition (with 4 input ports) series / 9-channel 4K high definition series / 9-channel high definition series front panel is shown as in Figure 1-2.



Figure 1-2







The 16-channel high definition series front panel is shown as in Figure 1-3.



Figure 1-3

Please refer to the following sheet for detailed information.

Name	Icon	Function
Power button		Press it for three seconds to boot up or shut down the device.

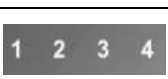
Name	Icon	Function
		Press it three times within one second, it can clear device configuration.
Power indicator light		The indicator light becomes on when system boots up.
Network indicator light		The indicator light becomes on when abnormal network event occurs (offline, IP conflict and etc.)
USB port		Connect to external USB device.
Alarm indicator light		The light becomes on when there is an alarm.
HDD indicator light		N/A
IR receiver		N/A
Output indicator light		<p>It is to display output port working mode.</p> <ul style="list-style-type: none"> <li>For 9-channel 4K high definition series/ 9-channel 4K high definition (with 4 input ports) series/9-channel high definition series, only the channel 1 to channel 9 indicator light is effective.</li> <li>For 16-channel high definition series, only the channel 1 to channel 16 indicator light is effective.</li> </ul>

**1.2.3 12-channel 4K high definition series/12-channel 4K high definition (with 4 input ports) series/ 15-channel 4K high definition series/15-channel 4K high definition (with 4 input ports) series/ 18-channel 4K high definition series/18-channel 4K high definition (with 4 input ports) series/ 21-channel 4K high definition series/21-channel 4K high definition (with 4 input ports) series**

The front panel is shown as below. See Figure 1-4.



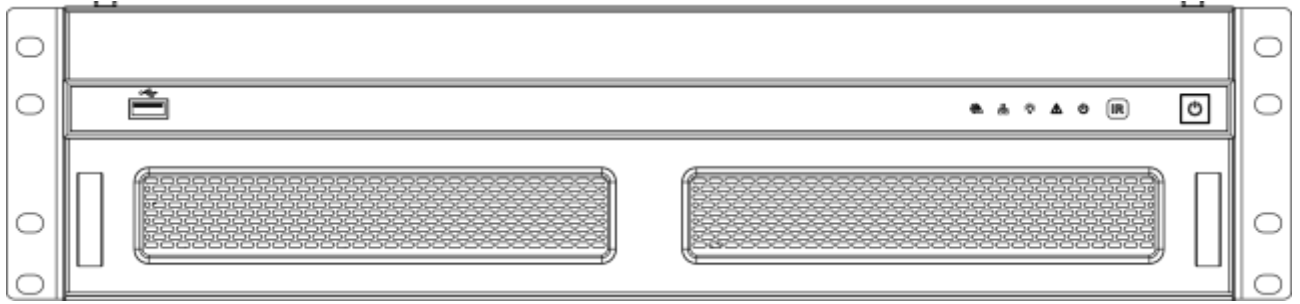









Figure 1-4

Please refer to the following sheet for detailed information.

Name	Icon	Function
Power button		Press it for three seconds to boot up or shut down the device.
IR receiver		N/A
Power indicator light		The indicator light becomes on when system boots up.
Alarm indicator light		The light becomes on when there is an alarm.
Running indicator light		The light is on when device is running.
Network indicator light		N/A
Fan indicator light		N/A
USB port		Connect to external USB device.

## 1.3 Rear Panel

### 1.3.1 1-channel 4K High Definition Series

The rear panel is shown as below. See Figure 1-5.

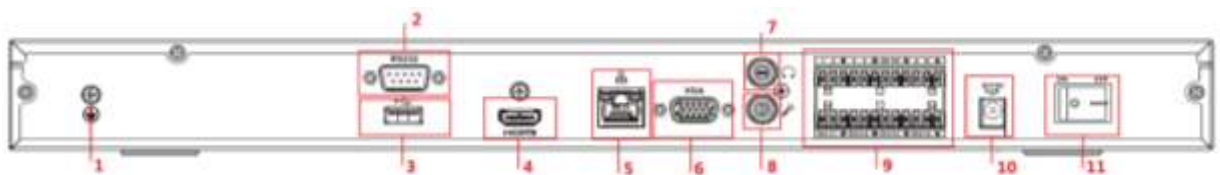

Figure 1-5

Please refer to the following sheet for detailed information.

SN	Port Name	SN	Port Name	SN	Port Name
1	Ground screw hole	2	RS232 port	3	USB port
4	HDMI port	5	Network interface(10M/100M/1000M self-adaptive Ethernet port)	6	VGA port
7	Audio talk output port RCA OUT	8	Audio talk input port RCA IN	9	4-channel alarm input, 4-channel alarm output, RS485 port.
10	Power socket	11	Power switch		

### 1.3.2 4-channel 4K high definition series

The rear panel is shown as below. See Figure 1-6.

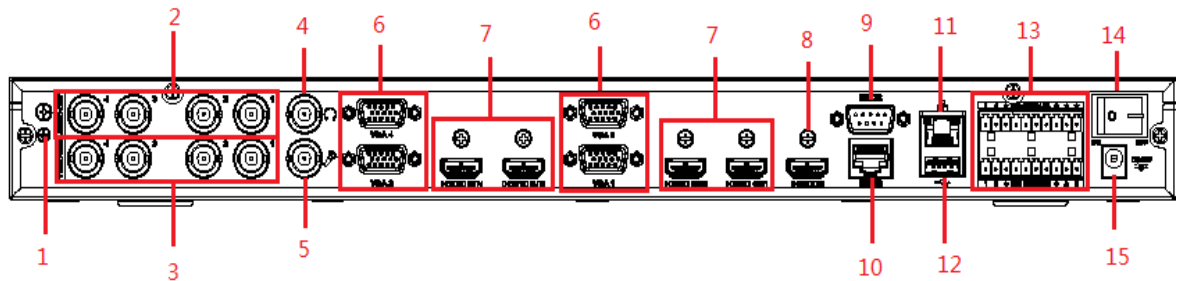

Figure 1-6

Please refer to the following sheet for detailed information.

SN	Port Name	SN	Port Name	SN	Port Name
1	Ground screw hole	2	Audio output port(BNC)	3	Video output port (BNC)
4	Audio talk input port	5	Audio talk output port	6	VGA port
7	HDMI output port	8	HDMI input port	9	RS232 port
10	RS232 port to control the screen	11	Network interface(10M/100M/1000M self-adaptive Ethernet port)	12	USB port
13	Alarm input, alarm output, standard RS485 port	14	Power on-off button	15	Power socket

### 1.3.3 9-channel 4K high definition (with 4 input ports) series

The rear panel is shown as below. See Figure 1-7.

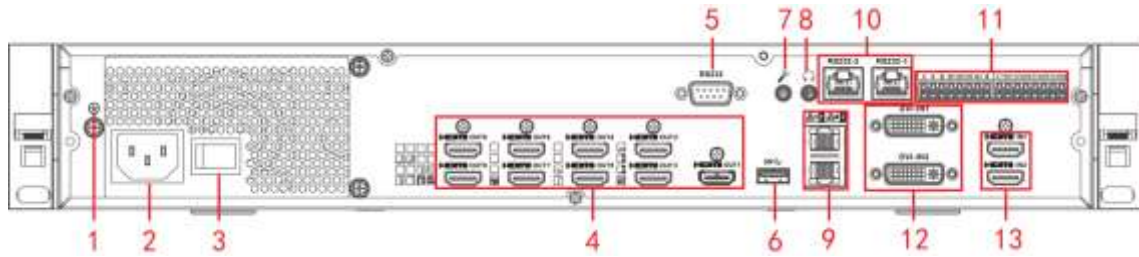

Figure 1-7

Please refer to the following sheet for detailed information.

SN	Port Name	SN	Port Name	SN	Port Name
1	Ground screw hole	2	Power socket	3	Power on-off button
4	HDMI output port	5	RS232 port	6	USB3.0 port
7	Audio talk input port	8	Audio talk output port	9	Network interface(10M/100M /1000M self-adaptive Ethernet port)
10	RS232 port to control the screen	11	Alarm input, alarm output, standard RS485 port	12	DVI-I input port
13	HDMI input port	-	-	-	-

### 1.3.4 9-channel 4K high definition series

The rear panel is shown as below. See Figure 1-8.

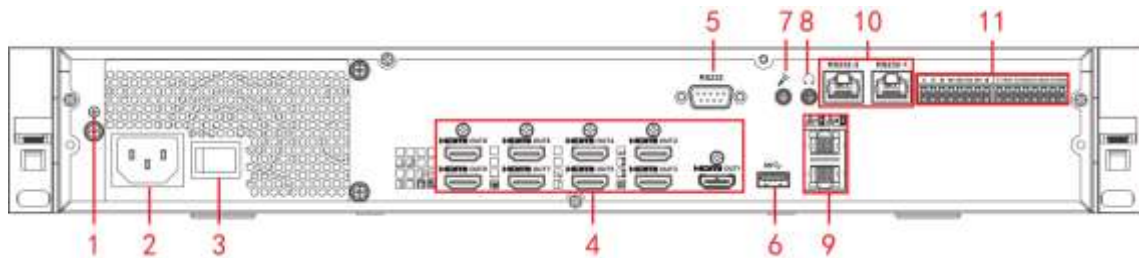

Figure 1-8

Please refer to the following sheet for detailed information.

SN	Port Name	SN	Port Name	SN	Port Name
1	Ground screw hole	2	Power socket	3	Power on-off button
4	HDMI input port	5	RS232 port	6	USB3.0 port
7	Audio talk input port	8	Audio talk output port	9	Network interface(10M/100M/1000M self-adaptive Ethernet port)
10	RS232 port to control the	11	Alarm input, alarm output, standard RS485	-	-

	screen		port		
--	--------	--	------	--	--

### 1.3.5 1-channel High Definition Series

The rear panel is shown as below. See Figure 1-9.

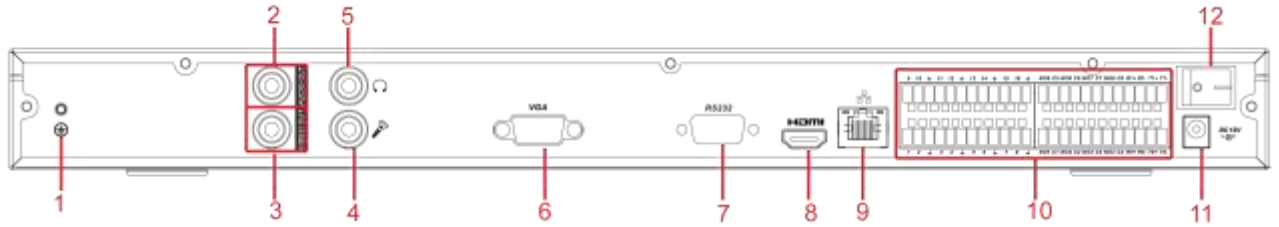

Figure 1-9

Please refer to the following sheet for detailed information.

SN	Port Name	SN	Port Name	SN	Port Name
1	Ground screw hole	2	Audio output port(BNC)	3	Video output port (BNC)
4	Audio talk input port	5	Audio talk output port	6	VGA port
7	RS232 port	8	HDMI port	9	Network interface(10M/100M/1000M self-adaptive Ethernet port)
10	Relay input, relay output, duplex RS485 port	11	Power socket	12	Power switch

### 1.3.6 4-channel High Definition Series

The rear panel is shown as in Figure 1-10.

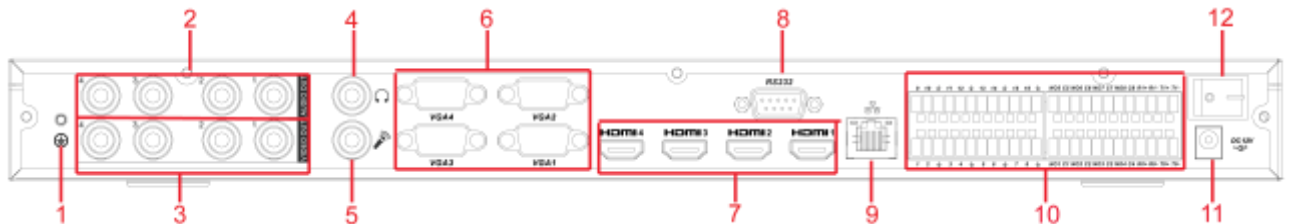

Figure 1-10

Please refer to the following sheet for detailed information.

SN	Port Name	SN	Port Name	SN	Port Name
1	Ground screw hole	2	Audio output port(BNC)	3	Video output port (BNC)
4	Audio talk output port	5	Audio talk input port	6	VGA port
7	HDMI port	8	RS232 port	9	Network interface(10M/100M/1000M self-adaptive Ethernet port)

10	Relay input, relay output, duplex RS485 port	11	Power socket	12	Power switch
----	--	----	--------------	----	--------------

### 1.3.7 9-channel High Definition Series

The rear panel is shown as below. See Figure 1-11.

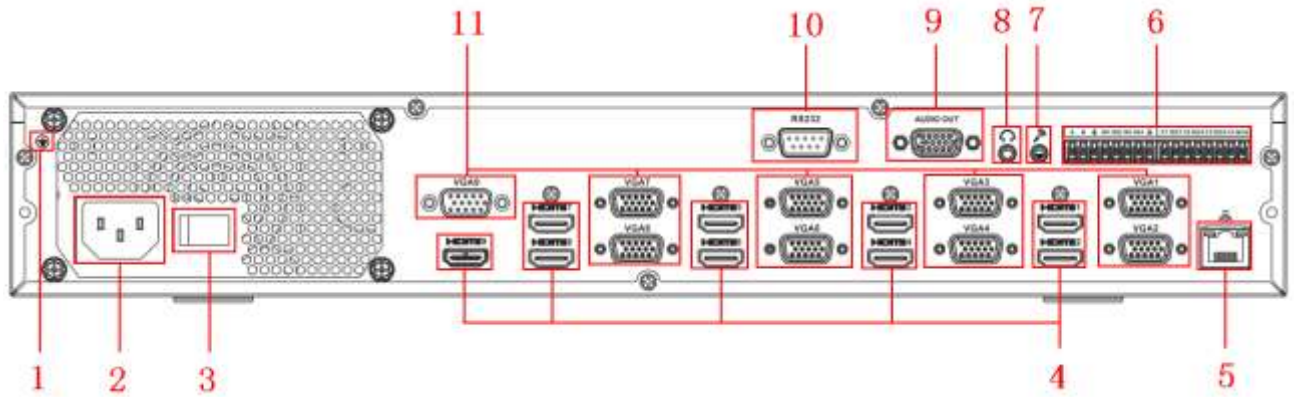

Figure 1-11

Please refer to the following sheet for detailed information.

SN	Port Name	SN	Port Name	SN	Port Name
1	Ground screw hole	2	Power switch	3	Power socket
4	HDMI port	5	Network interface(10M/100M/1000M self-adaptive Ethernet port)	6	Relay input, relay output, standard RS485 port.
7	Audio talk input port	8	Audio talk output port	9	Audio output port
10	RS232 port	11	VGA port		

### 1.3.8 16-channel High Definition Series

The rear panel is shown as below. See Figure 1-12.

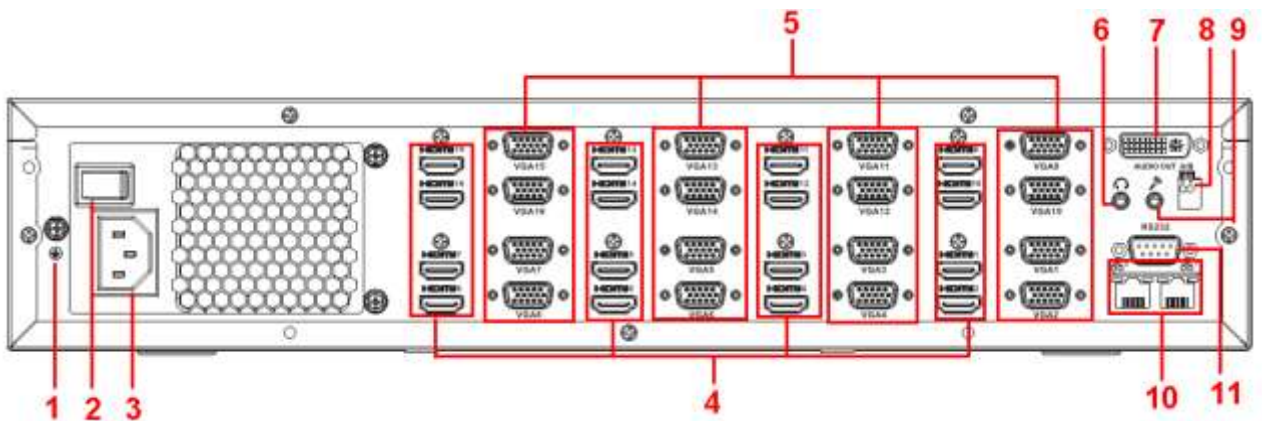

Figure 1-12

Please refer to the following sheet for detailed information.

SN	Port Name	SN	Port Name	SN	Port Name
1	Ground screw hole	2	Power switch	3	Power socket
4	HDMI port (16)	5	VGA port (16)	6	Audio talk output port
7	Audio output port	8	Standard RS485 port	9	Audio talk input port
10	Network interface(10M/100M/1000M self-adaptive Ethernet port)	11	RS232 port		

**1.3.9 12-channel 4K high definition series/12-channel 4K high definition (with 4 input ports) series/ 15-channel 4K high definition series/15-channel 4K high definition (with 4 input ports) series/ 18-channel 4K high definition series/18-channel 4K high definition (with 4 input ports) series/ 21-channel 4K high definition series/21-channel 4K high definition (with 4 input ports) series**

The 21-channel 4K high definition series/21-channel 4K high definition (with 4 input ports) series rear panel is shown as below. See Figure 1-13.

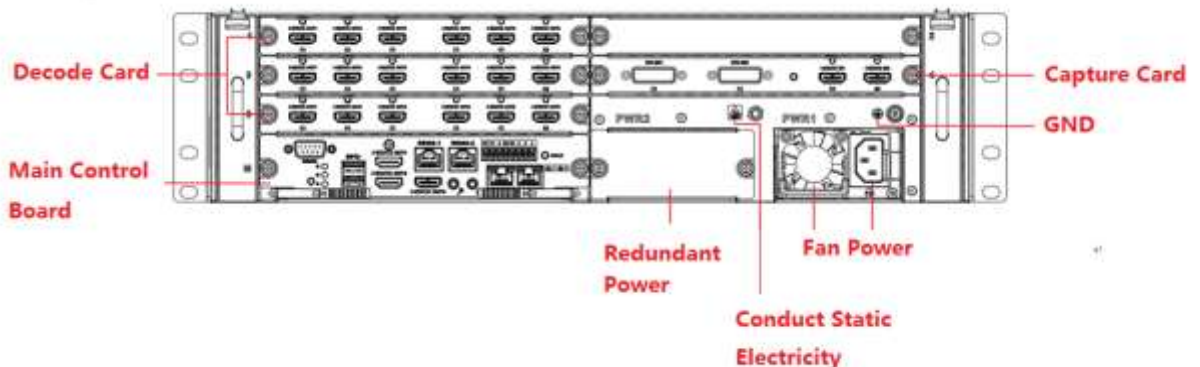

Figure 1-13

The 18-channel 4K high definition series/18-channel 4K high definition (with 4 input ports) series rear panel is shown as below. See Figure 1-14.

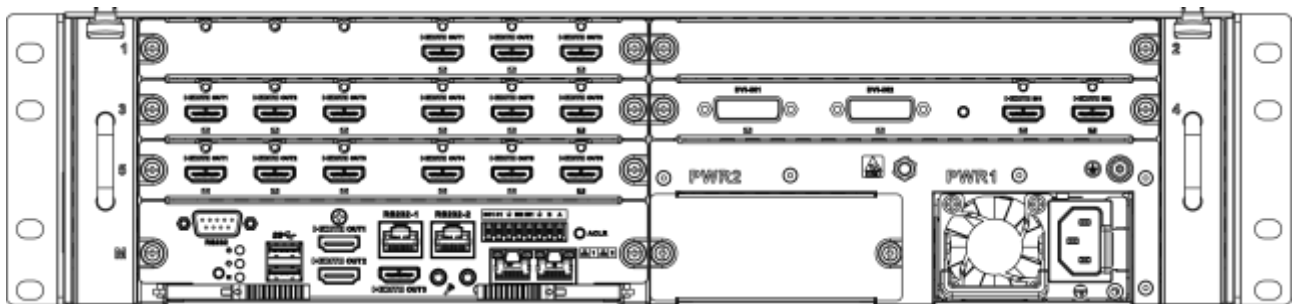

Figure 1-14

The 15-channel 4K high definition series/15-channel 4K high definition (with 4 input ports)

series rear panel is shown as below. See Figure 1-15.

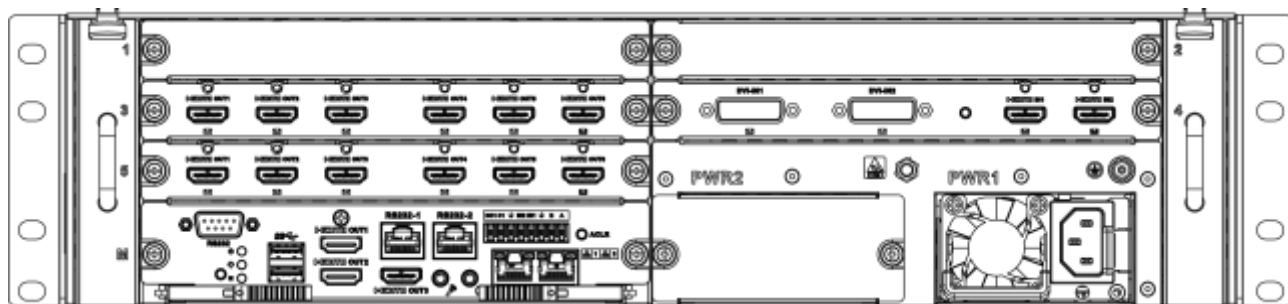

Figure 1-15

The 12-channel 4K high definition series/12-channel 4K high definition (with 4 input ports) series rear panel is shown as below. See Figure 1-16.

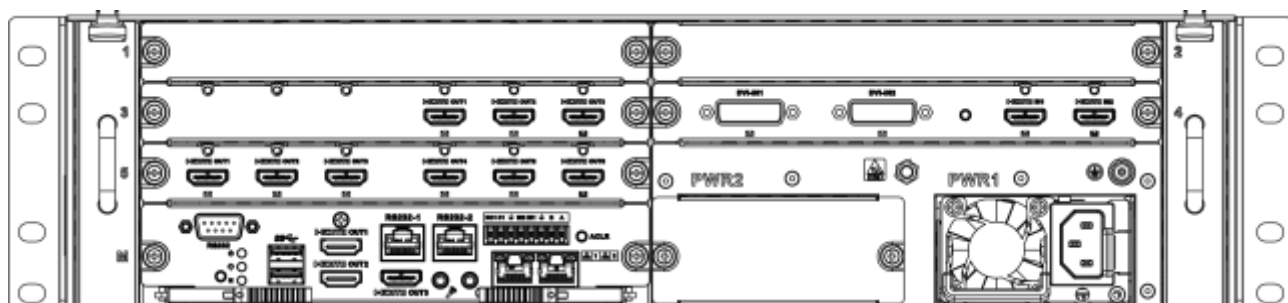

Figure 1-16

**Note**

- For the above four series, they only have different decode card types. The rest parts are the same.
- For XX-channel 4K high definition series and XX-channel 4K high definition (with 4 input ports) series, the only difference is one series has the capture card and the other does not have capture card. The rest parts are the same.

**Main control board**

The control board interface is shown as below. See Figure 1-17.

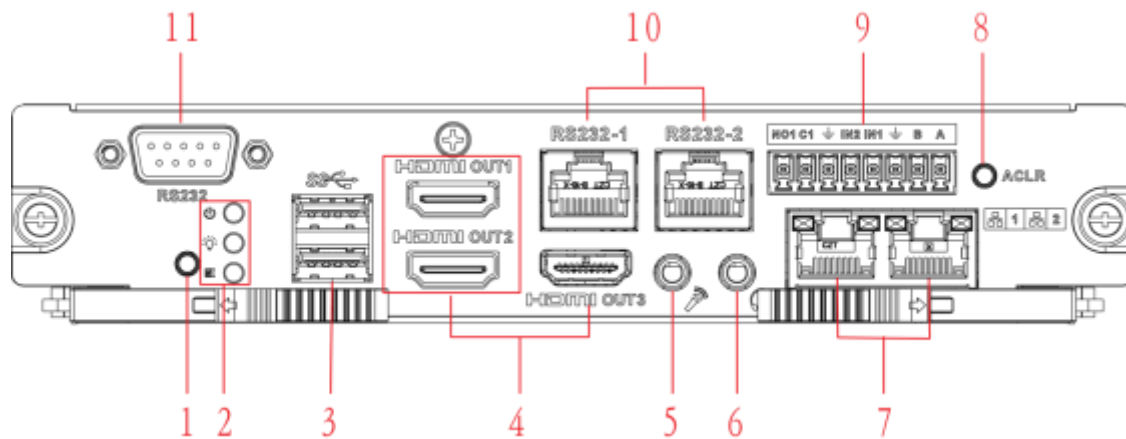

Figure 1-17

Please refer to the following sheet for detailed information.

SN	Name	SN	Name	SN	Name
1	Default button	2	<ul style="list-style-type: none"> <li>● Main control board power indicator light,</li> <li>● system status indicator light,</li> <li>● PCI-E status indicator light</li> </ul>	3	USB port
4	HDMI output port	5	Audio talk input port	6	Audio talk output port
7	Network port	8	Clear alarm button	9	<ul style="list-style-type: none"> <li>● 2-channel alarm input, 1-channel alarm output ,</li> <li>● RS485 port.</li> </ul>
10	RJ45 COM port	11	RS232 COM port	-	-

### Decode card

The 3-channel decode card is shown as in Figure 1-18.

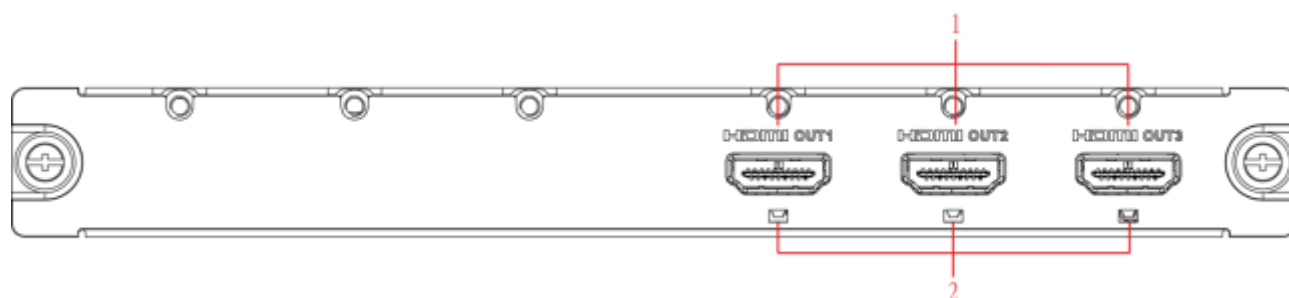

Figure 1-18

The 6-channel decode card is shown as in Figure 1-19.

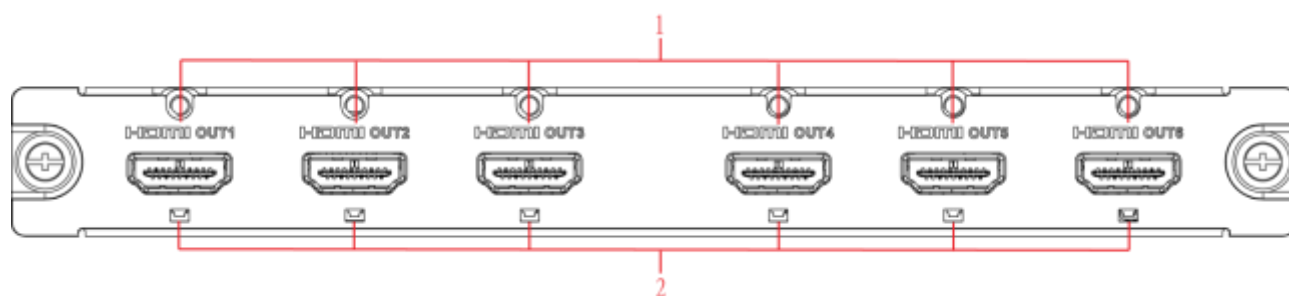

Figure 1-19

### Capture card

The capture card is shown as in Figure 1-20.



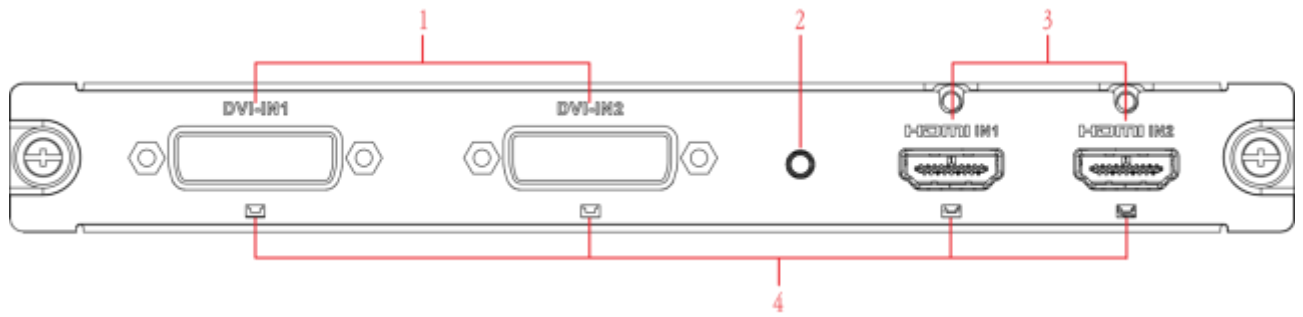

Figure 1-20

Please refer to the following sheet for detailed information.

SN	Name	SN	Name	SN	Name
1	DVI input port	2	Backup button	3	HDMI input port
4	Indicator light	-	-	-	-

**Note:**

When you connect it to the PC network port, please use crossover cable.  
 When you connect it to the PC via router or switcher, please use straight cable.

### 1.4 Connection

Please refer to the follow figure for connection information. See Figure 1-21.  
 The following figure is based on the 4-channel high definition series product.

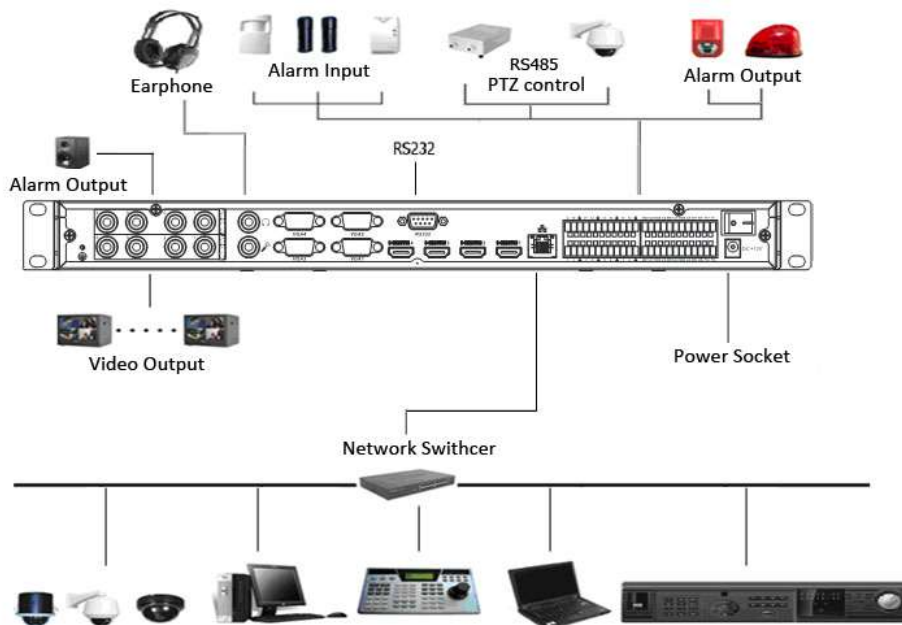

Figure 1-21

## 2 Operation

- The following operations are generally based on the 9-channel high definition series product.
- Slight different may be found in the user interface.

### 2.1 Boot Up and Shut Down

#### Boot up

Connect the device to the power and then press the power button in the rear panel. You can see the power indicator light becomes on and device boots up.

The system is in multiple-window display mode by default.

#### Shut down

You can press power button in the front panel for three seconds to shut down the device.

#### System Restore after Power Failure

When decoder is working, if the power failure occurs, the system can automatically connect to the front-end device and restore previous working status once the power connection becomes normal.

### 2.2 Login

#### 2.2.1 Preparation

Before log in, please make sure:

- Device connection is OK.
- You have set PC IP address, device IP address, subnet mask and gateway. (Please set the IP address of the same section for the PC and device. Please input corresponding gateway and subnet mask if there are routers.). When device booted up normally, please input account name **admin** and password **admin** via the PC COM port., then input `net -a` and then input IP, NETMASK, GATEWAY. The command mode is: `net -a [IP] [NETMASDK] [GATEWAY]`.

#### For example:

Username: admin

Password: admin

```
DeBug>net -a 192.168.XXX.XXX 255.255.XXX.XXX 192.168.XXX.XXX
```

- Use order ping `***.***.***.***`(Device IP address) to check connection is OK or not. Usually the return TTL value should be less than 255.
- Open IE and then input the address in the column.
- WEB control can be downloaded and installed automatically. System can download the latest Web control and remove the old one.
- You can run `uninstall web.bat` to remove the control

- System is compatible with web control of WINVISTA. But you need to disable account control item and then reboot the PC.

### 2.2.2 Login

Open the IE and then input the device IP address in the address column.

For example, if your device IP address is 192.168.1.100, then please input http://192.168.1.100 in IE address column. See Figure 2-1.

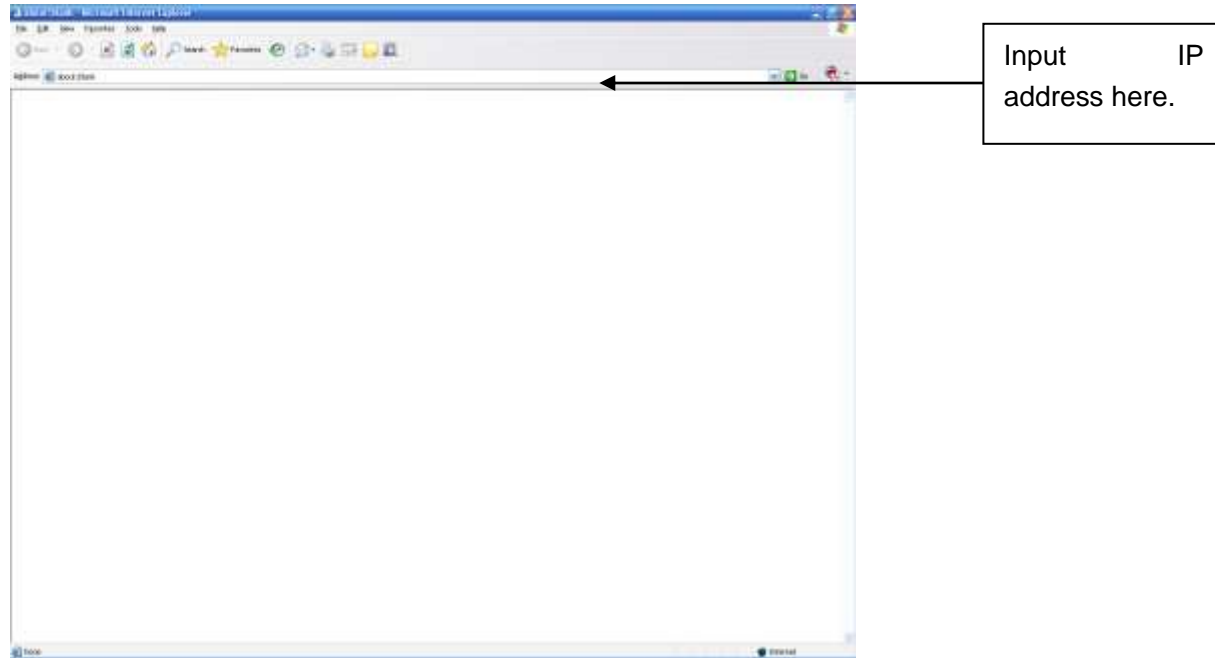

Figure 2-1

System pops up warning information to ask you whether install webrec.cab control or not. Please click yes button.

If you can't download the ActiveX file, please modify your settings as follows. See Figure 2-2.

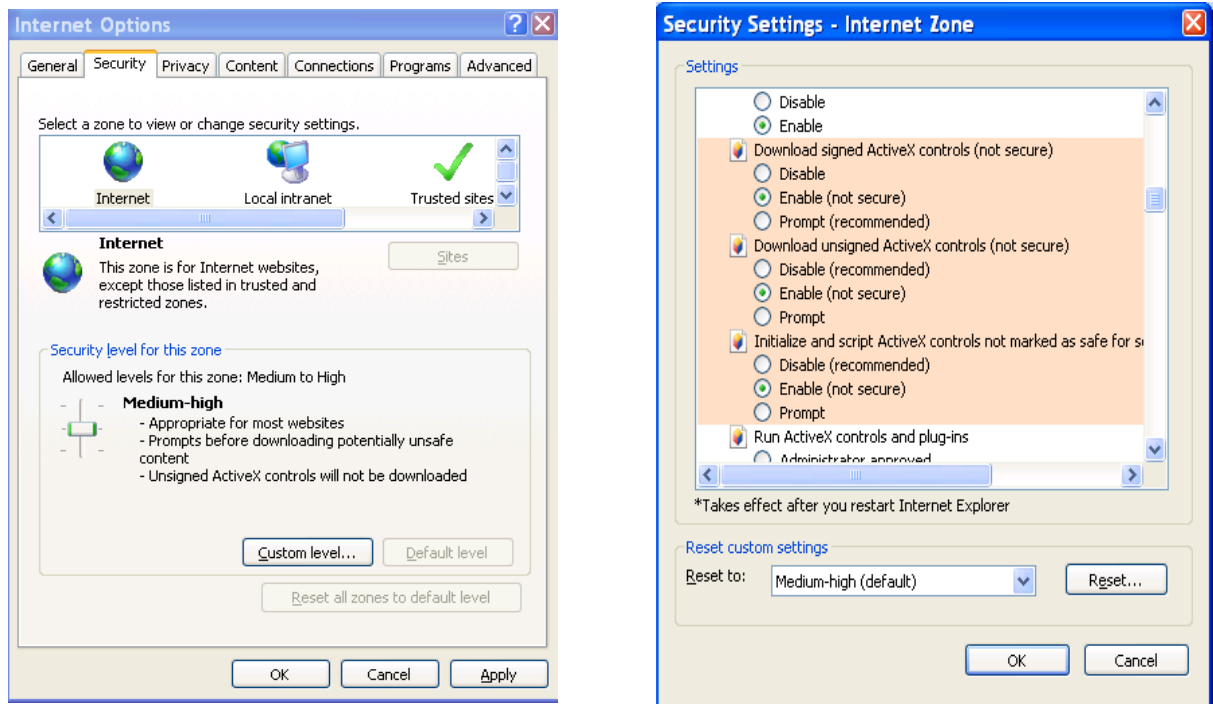

Figure 2-2

After installation, the interface is shown as below. See Figure 2-3.



Figure 2-3

Please input your user name and password and then click Login button.

- Default factory name is **admin** and password is **admin**.
- **Note: For security reasons, please modify your password after you first login.**

Now you can see system pops up the following dialogue box to remind you to change the default password. See Figure 2-4.

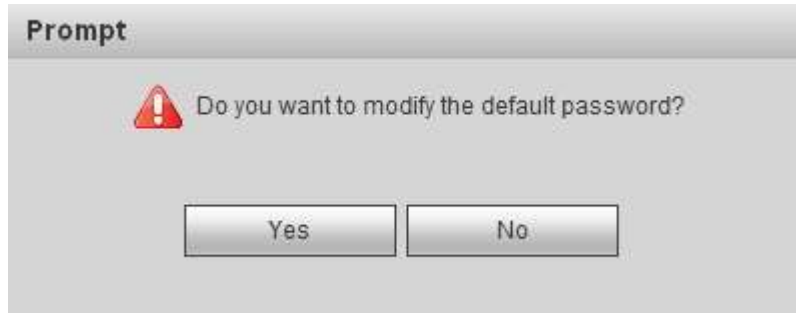

Figure 2-4

Click Yes button, you can see the Modify Password dialogue box. Please input the new password twice and then click the Yes button. See Figure 2-5.  
Click No button to remain the default password.



Figure 2-5

## 2.3 Main Window

After login successfully, you can go to the main interface.

For 1-channel 4K high definition series/4-channel 4K high definition series/1-channel high definition series/4-channel high definition series, the interface will be shown as Figure 2-6.

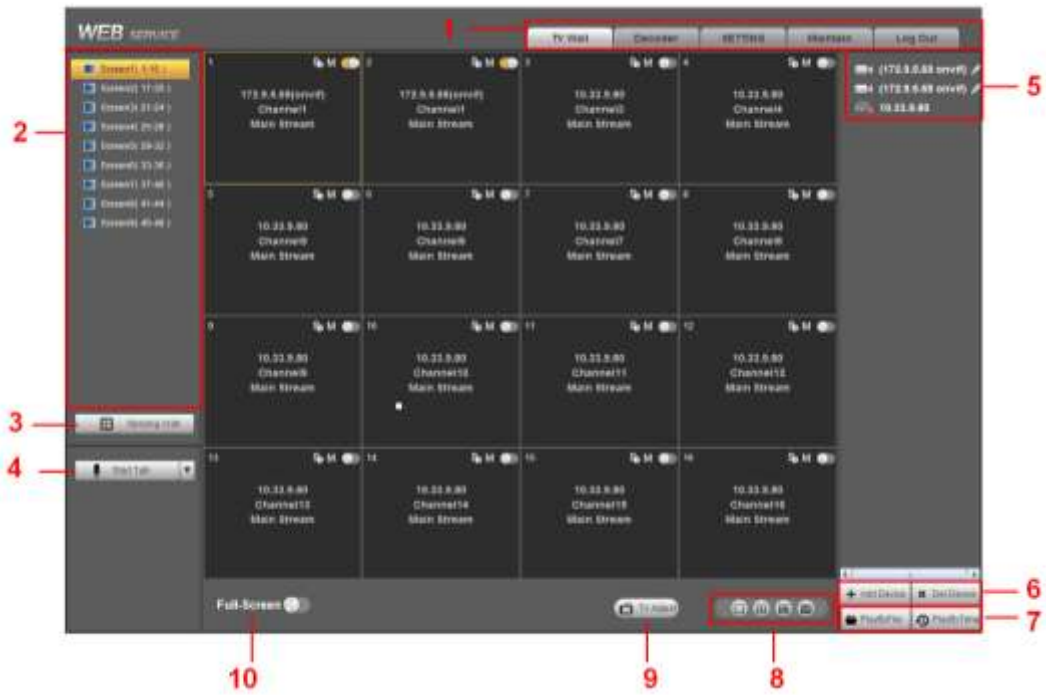

Figure 2-6

For 9-channel high definition series/16-channel high definition series, the interface is shown as in Figure 2-7.

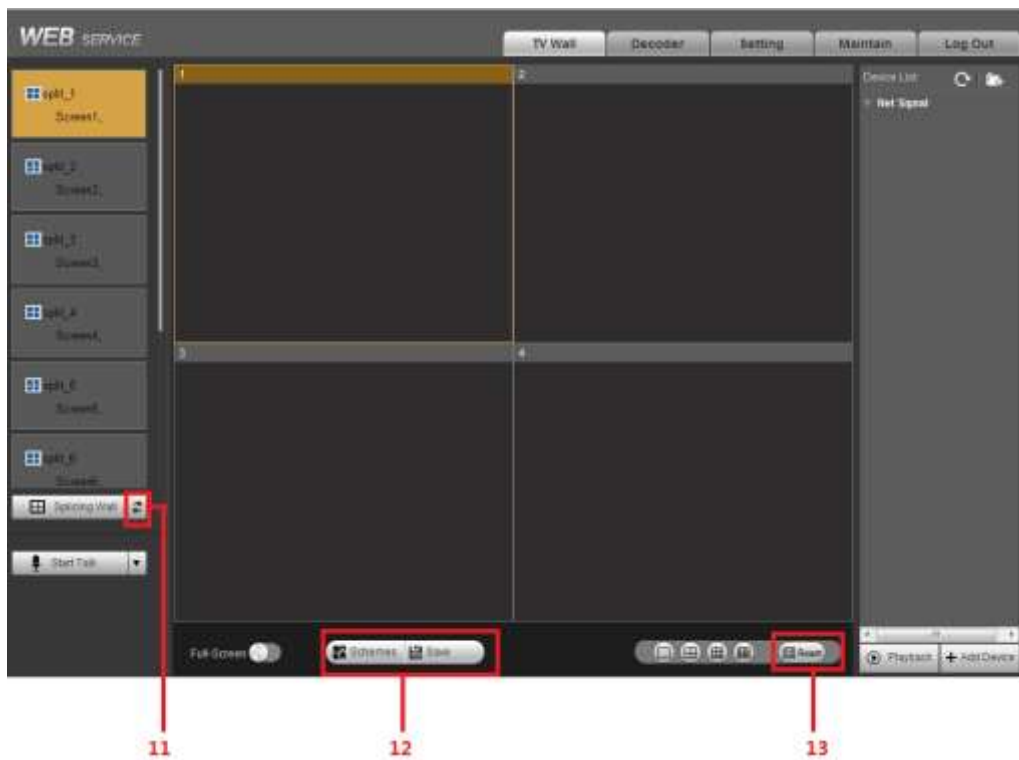

Figure 2-7

For 4-channel 4K high definition series/ 9-channel 4K high definition series/9-channel 4K high definition (with 4 input ports) series, the interface is shown as Figure 2-8.

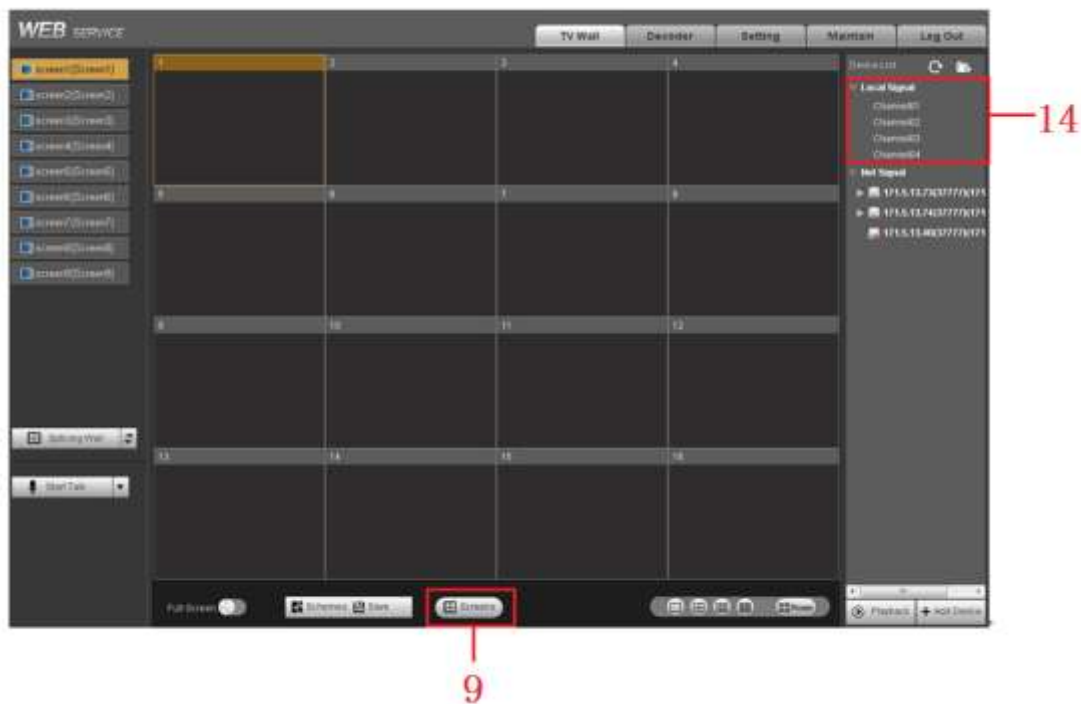

Figure 2-8

For 12-channel 4K high definition series/12-channel 4K high definition (with 4 input ports) series/ 15-channel 4K high definition series/15-channel 4K high definition (with 4 input ports) series/ 18-channel 4K high definition series/18-channel 4K high definition (with 4 input ports) series/ 21-channel 4K high definition series/21-channel 4K high definition (with 4 input ports) series, the interface is shown as below. See Figure 2-9.



Figure 2-9

Please refer to the following sheet for detailed information.

<b>SN</b>	<b>Name</b>	<b>SN</b>	<b>Name</b>
1	System menu	2	Screen No.
3	Splicing wall	4	Bidirectional talk
5	Connected front-end device list	6	Add/delete device
7	Playback	8	Window split
9	TV adjustment/screen manager	10	Full-screen button
11	Refresh	12	Scheme manager/Save
13	Roam	14	Local signal

**Note:**

- For detailed operation introduction, please refer to our resource CD included in your package for electronic version of the User's Manual.
- This quick start guide is for reference only. All the designs and software here are subject to change without prior written notice.
- All trademarks and registered trademarks mentioned are the properties of their respective owners.
- If there is any uncertainty or controversy, please refer to the final explanation of us.
- Please visit our website or contact your local retailer for more information.