

# Network Video Recorder

## NVR304-EP-B Series



### Key Features

- Support Ultra 265/H.265/H.264 video formats
- 16/32-channel input
- Third-party IP cameras supported with ONVIF conformance: Profile S, Profile G, Profile T
- Support 2-ch HDMI, 1-ch VGA, HDMI2 at up to 4K(3840x2160) resolution
- HDMI1/VGA and HDMI2 independent outputs provided
- Up to 12 Megapixels resolution recording
- 4 SATA HDDs, Up to 8TB for each HDD
- Various fisheye dewarping modes for live view and playback for both web interface and GUI
- Support for 12V Power output
- Plug & Play with up to 16 independent PoE network interfaces
- ANR technology to enhance the storage reliability when the network is disconnected
- Support cloud upgrade

## Specifications

Model	NVR304-16EP-B	NVR304-32EP-B
<b>Video/Audio Input</b>		
IP Video Input	16-ch	32-ch
Two-way Audio Input	1-ch, RCA	
<b>Network</b>		
Incoming Bandwidth	160Mbps	320Mbps
Outgoing Bandwidth	320Mbps	
Remote Users	128	
Protocols	P2P, UPnP, NTP, DHCP, PPPoE	
<b>Video/Audio Output</b>		
HDMI/VGA output	HDMI1/VGA: 1920x1080p /60Hz, 1920x1080p /50Hz, 1600x1200 /60Hz, 1280x1024 /60Hz, 1280x720 /60Hz, 1024x768 /60Hz HDMI2: 4K (3840x2160) /60Hz, 4K (3840x2160) /30Hz, 1920x1080p /60Hz, 1920x1080p /50Hz, 1600x1200 /60Hz, 1280x1024 /60Hz, 1280x720 /60Hz, 1024x768 /60Hz	
Recording Resolution	12MP/8MP/6MP/5MP/4MP/3MP/1080p/960p/720p/D1/2CIF/CIF	
Audio Output	1-ch, RCA	
Synchronous Playback	16-ch	
Corridor Mode Screen	3/4/5/7/9/10/12/16	3/4/5/7/9/10/12/16/32
<b>Decoding</b>		
Decoding format	Ultra 265, H.265, H.264	
Live view/Playback	12MP/8MP/6MP/5MP/4MP/3MP/1080p/960p/720p/D1/2CIF/CIF	
Capability	3 x 12MP@25, 4 x 4K@30, 8 x 4MP@30, 16 x 1080p@30, 32 x 960p@25	
<b>Hard Disk</b>		
SATA	4 SATA interfaces	
Capacity	up to 8TB for each HDD	
<b>Smart</b>		
VCA Detection	Face detection, Intrusion detection, Cross line detection, Audio detection, Defocus detection, Scene change detection, Auto tracking	
VCA Search	Face search, Behavior search	
Statistical Analysis	People counting	
<b>External Interface</b>		
Network Interface	1 RJ45 10M/100M/1000M self-adaptive Ethernet Interface	
Serial Interface	1 x RS485	
USB Interface	Front panel: 2 x USB2.0 Rear panel: 1 x USB3.0	
Alarm In	16-ch	
Alarm Out	4-ch	
Power Output	12 VDC	
<b>PoE</b>		
Interface	16 independent 100 Mbps PoE network interfaces	
Max Power	Max 30W for single port Max 200W in total ( 12.5W for each )	

Supported Standard	IEEE 802.3at
<b>General</b>	
Power Supply	100 ~ 240 VAC Power Consumption: ≤ 20 W( without HDD )
Working Environment	-10°C ~ + 55°C ( +14°F ~ +131°F ), Humidity ≤ 90% RH(non-condensing)
Dimensions(W×D×H)	442 mm× 425mm×86mm (17.4" × 16.7"×3.4" )
Weight ( without HDD )	≤ 5.24 Kg ( 11.55 lb )

## Dimensions

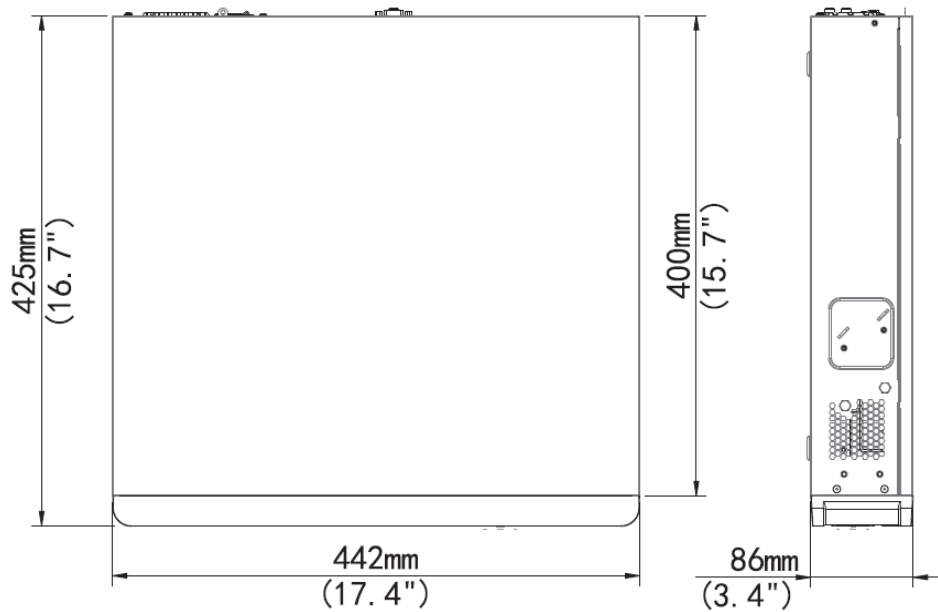

## Rear Panel

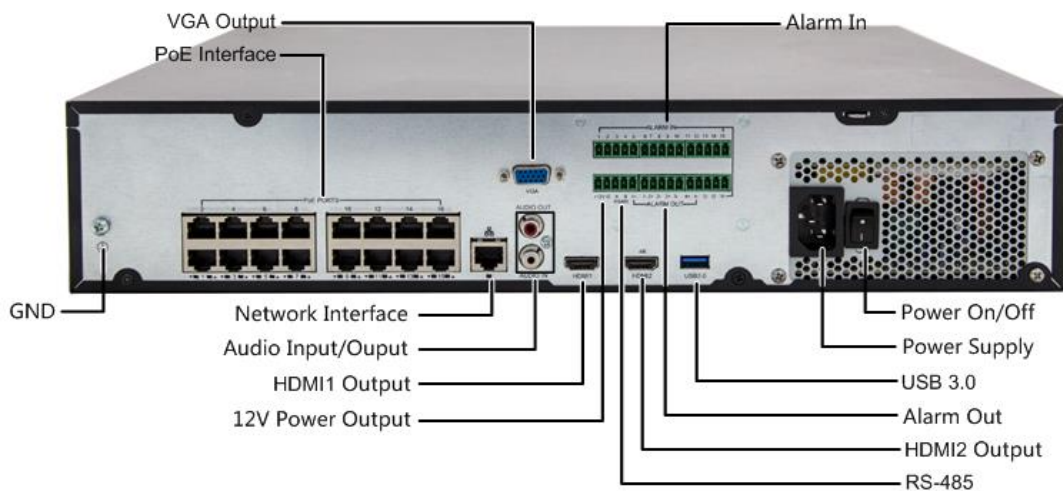

**Zhejiang Uniview Technologies Co., Ltd.**

Building No.10, Wanlun Science Park, Jiangling Road 88, Binjiang District, Hangzhou, Zhejiang, China

Email: [overseasbusiness@uniview.com](mailto:overseasbusiness@uniview.com); [globalsupport@uniview.com](mailto:globalsupport@uniview.com)

<http://sgcdn.uniview.com>

©2016-2018 Zhejiang Uniview Technologies Co.,Ltd. All rights reserved.

\*Product specifications and availability are subject to change without notice.