

Wire intercom

Model No. CM-810,800S

COMMAX
Blooming Life, HomeNetwork



CM-810



CM-800S

COMMAX Co.,Ltd.

513-11, Sangdaewon-dong, Jungwon-gu, Seongnam-si, Gyeonggi-do, Korea
Int'l Business Dept. : Tel.; +82-31-7393-540~550 Fax.; +82-31-745-2133
Web site : www.commax.com

Printed In Korea / 2008. 11

COMMAX Co.,Ltd.

- Thank you for purchasing COMMAX products.
- Please carefully read this User's Guide (in particular, precautions for safety) before using a product and follow instructions to use a product exactly.
- The company is not responsible for any safety accidents caused by abnormal operation of the product.

Contents

1. Greetings.....	1
2. Warnings and caution.....	2
3. Part name and its functions.....	4
4. Operation.....	5
5. Wring Method.....	7
6. Specification.....	8









	Instructions for users
Level-B product	The product is registered for electromagnetic compatibility for household use and can be used in all areas including residential areas.

1. Greetings



- Thank you for purchasing our Commax product.
- You should read this user's manual carefully before operating the unit.
- This common method H/A system provides residents of apartment buildings with safety and convenience based on various built-in functions that protect homes from disasters such as crimes, natural disasters, etc.

2. Warnings and caution

Please follow the things described below in order to prevent any danger or property damage.

 <p>Warning</p> <p>It may cause a serious damage or injury if violated.</p>	 Prohibition.  No disassembly  No touch  Must follow strictly.  Shows plugging out the power cord without an exception  Shows the warning and caution for an electric shock.  Shows the warning and caution for a fire.
 <p>Caution</p> <p>It may cause a minor damage or injury if violated.</p>	

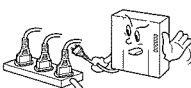
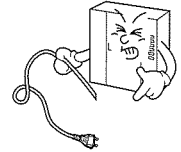
Warning

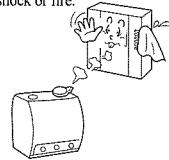
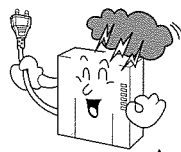
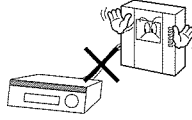
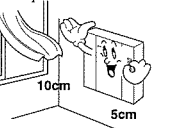

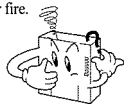
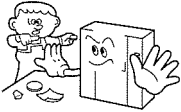
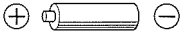

<p>Please don't use several products at the same time on one power socket.</p> <ul style="list-style-type: none"> It may cause a fire due to an abnormal overheating.  <p>Prohibition Fire</p>	<p>Please don't bend the power cable excessively or it may cause an electric shock.</p> <ul style="list-style-type: none"> fire when using a damaged power cable.  <p>Prohibition Electric shock Fire</p>	<p>Please don't handle the power cable with a wet hand.</p> <ul style="list-style-type: none"> It may cause an electric shock.  <p>Prohibition Fire</p>	<p>Please plug out the power cable from the socket when not using it for a long period of time.</p> <ul style="list-style-type: none"> It may shorten the product lifespan or cause a fire.  <p>Request Fire</p>
<p>Please don't install the product in the place where there is much oil, smoke or humidity.</p> <ul style="list-style-type: none"> It may cause an electric shock or fire.  <p>Prohibition Electric shock Fire</p>	<p>Please don't install the product with the lightning and thunder.</p> <ul style="list-style-type: none"> It may cause an electric shock or fire.  <p>Prohibition Electric shock Fire</p>	<p>Please don't use and connect this product with other products with different rated voltage.</p> <ul style="list-style-type: none"> It may cause a disorder or fire.  <p>Prohibition Fire</p>	<p>When installing the product that generates heat, please install the product away from the wall (10cm) for the ventilation.</p> <ul style="list-style-type: none"> It may cause a fire due to the increased internal temperature.  <p>Prohibition Fire</p>

Warning

Cleaning & Use

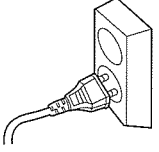
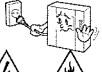
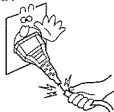
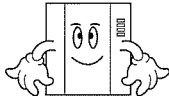
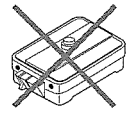
<p>Please don't disassemble, repair or rebuild this product arbitrarily (please contact the service center if a repair is needed).</p> <ul style="list-style-type: none"> It may cause an electric shock or fire.  <p>No disassembly Electric shock Fire Unplug</p>	<p>If an abnormal sound, burning smell or smoke is coming out of the product, please plug out the power cable and contact a service center.</p> <ul style="list-style-type: none"> It may cause an electric shock or fire.  <p>Electric shock Fire</p>	<p>Please don't insert any metallic or burnable materials into the ventilation hole.</p> <ul style="list-style-type: none"> It may cause an electric shock or fire.  <p>Prohibition Electric shock Fire</p>	<p>Please use only the designated batteries for the products of using DC power.</p> <ul style="list-style-type: none"> It may cause an electric shock or fire.  <p>Request</p>
---	--	---	--

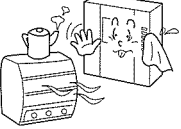
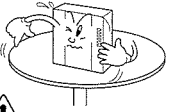
Caution

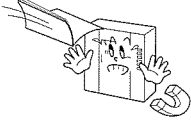
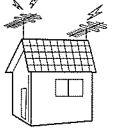
<p>Please plug the power cable firmly into the inner end.</p> <ul style="list-style-type: none"> It may cause a fire.  <p>Request Fire</p>	<p>Please hold the plug tightly when unplugging the power cable (a part of the copper wire may be disconnected if the grabbing is only made on the cord when pulling out the cable).</p> <ul style="list-style-type: none"> It may cause an electric shock or fire.  <p>Request Electric shock Fire</p>	<p>When connecting the power cables after cutting the cable, please install the product with power off.</p> <ul style="list-style-type: none"> It may cause an electric shock or fire.  <p>Request Electric shock Fire</p>	<p>When installing the product, please fix it firmly while using the wall-mounting unit and screws.</p> <ul style="list-style-type: none"> It may cause an injury from the falling object.  <p>Request</p>
<p>Please be careful when using an AC circuit breaker since there is a possibility of an electric shock.</p>  <p>Request Electric shock</p>	<p>Please check the use voltage and current for the DC-only products and use the appropriate rectifier.</p> <ul style="list-style-type: none"> It may cause a fire.  <p>Request Fire</p>	<p>Please avoid direct rays of the sun or heating devices at a time of installation.</p> <ul style="list-style-type: none"> It may cause a fire.  <p>Request Overheating Fire</p>	<p>Please don't install the product on an unstable place or small support board.</p> <ul style="list-style-type: none"> It may cause an injury if it falls down while in use.  <p>Request</p>
<p>When cleaning the product, please rub it with a soft and dry cloth after plugging out the power cable. (Please don't use any chemical products such as wax, benzene, alcohol or cleanser.)</p>  <p>Prohibition</p>	<p>Please don't drop the product on the ground and don't apply a shock.</p> <ul style="list-style-type: none"> It may cause a failure.  <p>Prohibition</p>	<p>Please use the designated connection cable within the maximum calling distance designated for the product.</p> <ul style="list-style-type: none"> It may reduce the product performance.  <p>Request</p>	

Cleaning & Use

3. Part Name and its functions

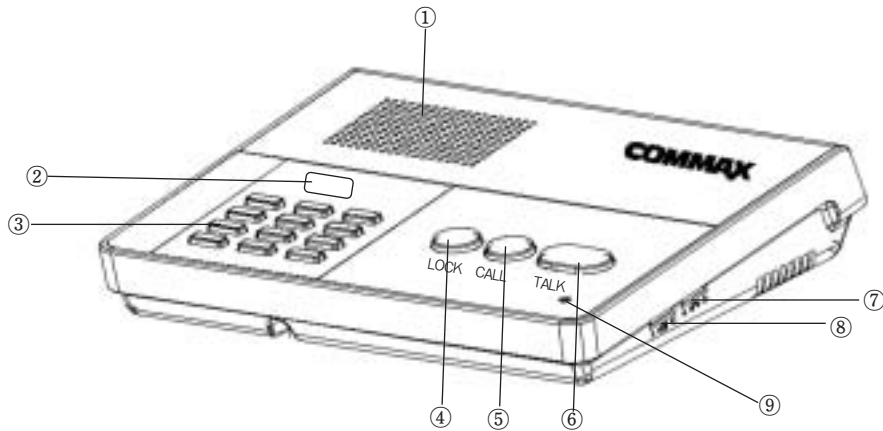

3-1 CM-810 Parts Name

NO	Description
①	Speaker
②	Display
③	Ten-key
④	LOCK(Priority Call)
⑤	CALL
⑥	TALK
⑦	Volume Control Dial
⑧	Call Sound Volume Control Dial.
⑨	MIC

- Volume Control Dial: it is to adjust the voice level from CM-800S.
- Ring Sound Volume Control Dial.: it is to adjust the ring sound level from CM-800S.

This product is open voice type.

Pressing "Talk" button will start communication and then pressing "Talk" again will end it.

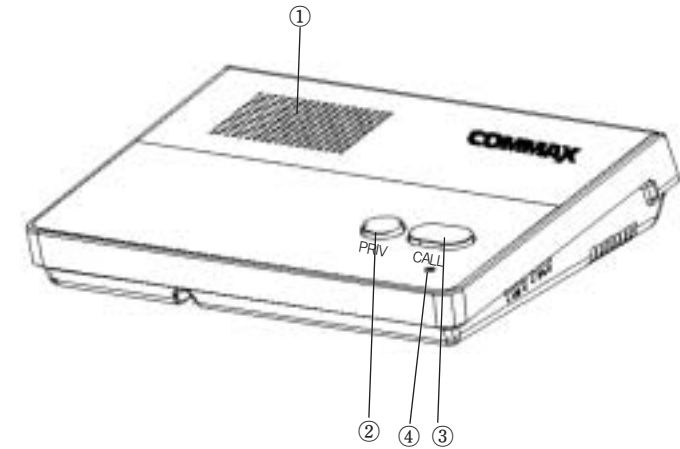

3-2 CM-800S Part Names

NO	Description
①	Speaker
②	Privacy Button
③	CALL Button
④	C-MIC

4. Operation

4-1 CM-810

** Making a call to CM-800S.

- 1) Press the desired number of CM-800S to talk and then "#" button.
The "beep" sound is heard.
Ex) paging first CM-800S: "1 + # (beep)"
 - Wrong number makes "Error" sound. (It is available from 1 to 10)
 - Pressing "*" button to conceal the registration of wrong number.
- 2) After the communication line is opened, pressing the "all" button to make a ring.
Ex) Paging first CM-800S: "1 + # (beep)" + "all" button.
 - During keep pressing "all" button only, there is a ring.

- 1) When you receive a call from other unit during talk, other unit's number is displayed.
Press“ #”button twice if you want to talk with other unit.
- Ex) when you receive a call from No.2 unit during talking with No.1, No.2 is displayed. Press“ #” to end the talk with No.1 unit and start to talk with No.2 unit.

** Public Notice function.(ALL CALL)

- 1) It is to use to make a public notice from CM- 810 to CM- 800S.
Ex) Press“ 0” and then“ #” to open all the lines of CM- 800S.

** Setup for CM- 810.(Master Unit)

- 1) Choice of the ring type out of two.
- 2) Setup Ring-time duration
 - It is available to set ring-time when CM- 810 receives a call from CM- 800S (from 1 to 20 Seconds).
- 3) Setup Method. (Ring type and ring-time duration).
 - Setup mode : Hold“ *”button for 2 seconds and release it in standby mode
 - Setup ring type out of two.
 - “ SD” sign and the number of unit in use blink in turn on the display when set-up mode is in.
 - Select 1 or 2 from Ten Key and then“ #” to move on to ring- duration setup mode with saving.
 - Press“ *”button to move on to ring duration setup mode without saving.
 - Setup ring-duration
 - It is to setup the time of ring-duration of CM- 810.
 - “ tE” sign and the number of CM- 800S in use blinks in turn on the display.
 - It is available to setup duration time from 1 to 20 seconds using ten- key.
 - Press“ #” button after enter the time.
 - And then it becomes standby mode automatically.
 - Press“ *”button to be out without saving.
 - ※ Wrong registration makes“ beep” sound.

4- 2 CM- 800S (Sub-Unit)

- 1) Pressing the call button makes ring.
- 2) You can talk with CM- 810 without any operation of CM- 800S.
- 3) Pressing“ privacy” button to stop delivering the voice from CM- 800S to CM- 810.

5. Wiring Method.

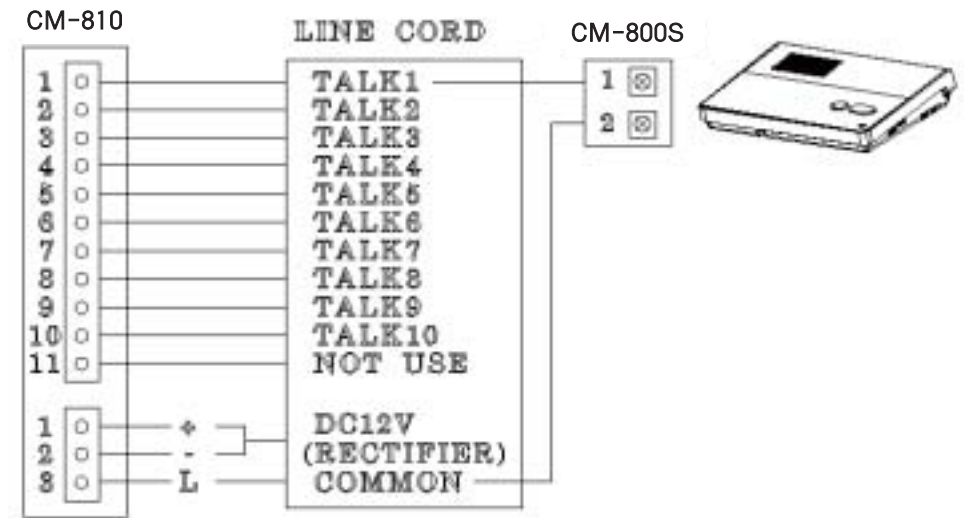

CM- 810 connecting terminal in rear side.

5- 1 Wiring.

-“ Line Cord” is used for wiring of CM- 810.

- 1) 1P terminal : connect to LINE CORD 11P CONNECTOR.
- 2) 3P terminal : connect to LINE CORD 3P CONNECTOR.
- 4) Power : Power source, DC 12V is connected with LINE CORD.
- 5) CM- 800S : connect to LINE CORD with 2 wires.(Max. of 300m)

** 12V, Trans type should be used as power source.



6. Specification

Item	Description
Wiring	To CM-800S : 2 wires (talk 2)
Rated Voltage	DC12V/ 1A
Transmission way	Half-Duplex
Display	-
Consumption	Standby: 60mA Max. : 370mA
Distance	CM810 - CM-800S : Max. 300m / (ϕ 0.65mm)
Working temperatue	10°C -40°C